

SR90 Series

(SR91, SR92, SR93, SR94)

Digital Controller

Instruction Manual

Please check that the delivered product is the correct item or specification you ordered.
Please do not begin operating this product before you read this instruction manual thoroughly and understand its contents.

Notice

Please ensure that this instruction manual is given to the final user of the instrument.

Preface

This instruction manual is meant for those who will be involved in the wiring, installation, operation and routine maintenance of the SR90 series (SR91, SR92, SR93 and SR94) and describes matters to be attended to in handling the SR90 series, how to install it, its wiring, its functions and operating procedures.

Keep this manual at the work site while handling the instrument and follow the guidance provided herein.

SHIMADEN CO., LTD.

Contents

Notice	1	7. Table of Measuring Range Codes	22
Preface	1	8. Explanation of Functions	23
1. Safety Rules	3	8-1. Events	23
2. Introduction	4	(1) Deviation alarm	23
2-1. Check before Use	4	(2) Absolute value alarm.....	23
(1) Confirmation of Model Codes	4	(3) Standby action	23
(2) Confirmation of Accessories	5	(4) No-standby action	23
2-2. Handling Instruction	5	(5) Control mode	23
3. Installation and Wiring	5	8-2. Selection of Event Standby Action Code.....	23
3-1. Installation Site (environmental conditions).....	5	8-3. Alarm Action Diagrams.....	24
3-2. Mounting	5	8-4. P.I.D.	24
3-3. External Dimensions and Panel Cutout	6	(1) P (Proportional band).....	24
3-4. Wiring.....	7	(2) I (Integral time).....	24
3-5. Terminal Layout.....	8	(3) D (Derivative time)	24
3-6. Terminal Arrangement Table	9	(4) MR (Manual Reset).....	24
3-7. Before Starting Operation	9	8-5. Lower Limit and Higher Limit Setting Limiters	24
4. Names and Functions of Parts on Front Panel 10		8-6. Proportional Cycle Time	25
5. Explanation of Screens and Setting	11	8-7. Control Output Characteristics	25
5-1. Parameter Flow.....	11	(1) One-output	25
5-2. Display upon Power-ON	12	(2) Two-output	25
5-3. How to Change Screens	12	8-8. External input (DI)	25
(1) How to change screens in screen group 0.....	12	(1) Set value bias (SB)	25
(2) How to change screen group 0 to/from screen group 1 ..	12	(2) Standby (STBY)	26
(3) How to change screen in screen group 1	12	(3) Control action characteristics (ACT)	26
(4) How to change set values (data)	13	8-9. Soft Start	26
5-4. Auto Return Function	13	(1) Conditions of soft start function is put in action.....	26
5-5. Procedure of Setting in Screen Group 0	13	(2) Conditions of soft start is released.....	26
(1) Setting of target set value (SV).....	13	9. Maintenance and Troubleshooting	27
(2) Manual setting of control output.....	13	9-1. Cause of Trouble and Troubleshooting	27
(3) AT (auto tuning).....	14	9-2. Error Codes, Causes and Remedies.....	27
(4) Standby mode (STBY)	15	(1) Input measured value problems.....	27
(5) Setting of event set value.....	16	(2) Heater break/loop alarm problems.....	27
(6) Set value bias	16	10. Record of Parameter Setting	28
6. Explanation of Screen Group and Setting	17	11. Specifications	29

1. Safety Rules

For matters regarding safety, potential damage to equipment and/or facilities, additional instructions and notes are indicated by the following headings.

WARNING: This heading indicates hazardous conditions that could cause injury or death of personnel unless extreme caution is exercised.

CAUTION: This heading indicates hazardous conditions that could cause damage to equipment and/or facilities unless extreme caution is exercised.

NOTE: This heading indicates additional instructions and/or notes.

The mark  represents a protective conductor terminal. Make sure to ground it properly.



WARNING

The SR90 series is designed for controlling temperature, humidity and other physical quantities of general industrial equipment. Avoid using it for control of devices upon which human life is dependent. When used, adequate and effective safety measures must be taken. No warranty is valid in the case of an accident arising from the use of this product without having taken such safety measures.

- For using this instrument, house it in a control box or the like to prevent terminals from coming into contact with personnel.
- Do not draw out the instrument out from its case. Do not let your hand or any conductive body into the case. It may lead to serious injury or death due to an electric shock.
- Make sure to ground protective conductor terminals.

CAUTION

To avoid damage to connected equipment, facilities or the SR90 itself due to a fault of the product, safety measures must be taken before usage, such as the installation of a fuse, an overheating protection device and the like. No warranty is valid in the case of an accident arising from the use of this product without such safety measures.

- The alert mark  on the plate affixed to the instrument:
On the terminal nameplate affixed to the case of this instrument, the alert mark  is printed. This is to warn you of the risk of electric shock which may result if the charger is touched while being energized.
- As a means to turn the power off, a switch or a breaker should be installed in the external power circuit to be connected to the power terminal of the instrument. Fix the switch or the breaker adjacently to the instrument in a position which allows it to be operated with ease, with an indication that it is a means of turning the power off. Use a switch or a breaker which meets IEC60947 requirements.
- Fuse:
Since the instrument does not have a built-in fuse, do not forget to install a fuse in the power circuit to be connected to the power terminal. A fuse should be positioned between a switch or a breaker and the instrument and mounted on the L side of the power terminal.
Fuse rating/characteristics: 250 V AC 0.5 A/medium lagged or lagged type.
Use a fuse which meets IEC60127 requirements.
- Voltage/current of a load to be connected to the output terminal and the event terminal should be within a rated range. Otherwise, the temperature will rise to reduce the life of the product and/or to result in problems with the product. For rated voltage/current, please refer to "11. Specifications".
The output terminal should be connected with a device which meets the requirements of IEC61010.
- A voltage/current different from that of the input specification should not be applied to the input terminal. It may reduce the life of the product and/or result in problems with the product. For rated voltage/current, please refer to "11. Specifications".
In the case of voltage or current input, the input terminal should be connected to a device which meets IEC61010 requirements.
The instrument is provided with a draft hole for heat discharge. Take care to prevent metal and other foreign matter from entering into it. Failure to do so may result in trouble with the instrument or may even cause a fire.
- Do not block the draft hole or allow dust or the like to stick to it. A rise in temperature or insulation failure may result in a reduction of the life of the product and/or problems with it or may cause a fire. For spaces between installed instruments, refer to "3-3.External Dimensions and Panel Cutout".
- It should be noted that repeated tolerance tests against voltage, noise, surge, etc., may lead to deterioration of the instrument.
- Users are prohibited from remodeling the product or using it in a prohibited way.

2. Introduction

2-1. Check before Use

This product has been fully inspected for quality assurance prior to shipment. Nevertheless, you are requested to make sure that there is no error, damage or shortage of delivered items by checking the model codes, the external view of the product, and the number of accessories.

Check the model codes affixed to the case of the product to ascertain if the respective codes designate what was specified when you ordered it, referring to the following code table.

SR90 series is based on 3 types of selectable codes SR91, SR92, and SR93/SR94.

(1) Confirmation of Model Codes

[Example of SR91 model type codes]

S R 9 1 - 8 Y - 9 0 - 0 N 0

- 1. Series
- 2. Input
- 3. Control output (1)
- 4. Power supply
- 5. Event
- 6. Option
 - Control output (2)
 - Heater break alarm
- Analog output
- Communication
- DI
- 7. Remarks

SR91

8: Universal input Thermocouple, R.T.D., Voltage (mV)

4: Current (mA), **6:** Voltage (V)

Y: Contact, **I:** Current, **P:** SSR drive voltage, **V:** Voltage

90: 100 to 240V AC, **08:** 24V AC/DC

0: None, **1:** Event output

N: None

Y: Contact, **I:** Current, **P:** SSR drive voltage, **V:** Voltage

1: Heater break alarm (30A) **2:** Heater break alarm (50A)

["1" or "2" is selectable only when control output 1 is Y or P and event output is added]

3: 0 to 10mV DC, **4:** 4 to 20mA DC, **6:** 0 to 10V DC

5: RS-485

8: DI (set value bias, STBY, or ACT) 1 point

0: Without, **9:** With

[Example of SR92 model type codes]

S R 9 2 - 8 Y - N - 9 0 - 0 0 0 0

- 1. Series
- 2. Input
- 3. Control output (1)
- 4. Control output (2)
- 5. Power supply
- 6. Event
 - Event output + heater break alarm
- 7. Analog output
- 8. Communication or DI
- 9. Remarks

SR92

8: Universal input Thermocouple, R.T.D., Voltage (mV)

4: Current (mA), **6:** Voltage (V)

Y: Contact, **I:** Current, **P:** SSR drive voltage, **V:** Voltage

N: None, **Y:** Contact, **I:** Current, **P:** SSR drive voltage, **V:** Voltage

90: 100 to 240V AC, **08:** 24V AC/DC

0: None, **1:** Event output

2: Event output + heater break alarm 30A

3: Event output + heater break alarm 50A

["2" or "3" is selectable only when control output 1 is Y or P.]

0: None, **3:** 0 to 10mV DC, **4:** 4 to 20mA DC, **6:** 0 to 10V DC

0: None, **5:** RS-485, **7:** RS-232C

8: DI (set value bias, STBY, or ACT) 1 point

0: Without, **9:** With

[Example of SR93/SR94 model type codes]

S R 9 3 - 8 Y - N - 9 0 - 0 0 0 0

- 1. Series
- 2. Input
- 3. Control output (1)
- 4. Control output (2)
- 5. Power supply
- 6. Event
 - Event output + heater break alarm
- 7. Option
 - Analog output
 - DI
 - Analog output + DI
- Communication
- 8. Remarks

SR93 or SR94

8: Universal input Thermocouple, R.T.D., Voltage (mV)

4: Current (mA), **6:** Voltage (V)

Y: Contact, **I:** Current, **P:** SSR drive voltage, **V:** Voltage

N: None, **Y:** Contact, **I:** Current, **P:** SSR drive voltage, **V:** Voltage

90: 100 to 240V AC, **08:** 24V AC/DC

0: None, **1:** Event output

2: Event output + heater break alarm 30A

3: Event output + heater break alarm 50A

["2" or "3" is selectable only when control output 1 is Y or P.]

00: None

30: 0 to 10mV DC, **40:** 4 to 20mA DC, **60:** 0 to 10V DC

08: DI (set value bias, STBY, or ACT) 1 point

38: 0 to 10mV DC + DI (set value bias, STBY, or ACT) 1 point

48: 4 to 20mA DC + DI (set value bias, STBY, or ACT) 1 point

68: 0 to 10V DC + DI (set value bias, STBY, or ACT) 1 point

05: RS-485, **07:** RS-232C

0: Without, **9:** With

(2) Confirmation of Accessories

This instruction manual	1 copy
The Communication interface instruction manual (in case optional communication function is added)	1 copy
Unit seals	1 sheet
Current detector for heater break alarm (CT) (in case optional heater break alarm function is added)	
For 30A: Model CTL-6-S	1 pc.
For 50A: Model CTL-12-S36-8	1 pc.

NOTE: For any problem with the product, shortage of accessories or request for information, please contact our agent or our sales office in your neighborhood.

2-2. Handling Instruction

Do not operate the keys on the front panel with a hard or sharply pointed object. Operate the keys only by softly touching them by your fingertips.

When cleaning the instrument, wipe it gently with a dry cloth. Never use solvent such as a thinner.

3. Installation and Wiring

3-1. Installation Site (environmental conditions)

CAUTION

This instrument should not be used in any of the places mentioned below.

Selection of these places may result in trouble with the instrument, damage to it or even a fire.

- ① Where flammable gas, corrosive gas, oil mist and particles that can deteriorate electrical insulation are generated or abundant.
- ② Where the temperature is below -10°C or above 50°C .
- ③ Where the relative humidity is above 90%RH or below the dew point.
- ④ Where highly intense vibration or impact is generated or transferred.
- ⑤ Near high voltage power lines or where inductive interference can affect the operation of the instrument.
- ⑥ Where the instrument is exposed to dew drops or direct sunlight.
- ⑦ Where the height is above 2000 m.
- ⑧ Outdoors.

NOTE: The environmental conditions belong to the installation category II of IEC60664 and the degree of pollution is 2.

3-2. Mounting

CAUTION

For safety's sake and to protect the functionality of the product, do not draw out its body from the case. If it needs to be drawn out for replacement or repair, call our agent or our sales office in your neighborhood.

- ① Cut a hole for mounting the controller in the panel by referring to the cutout drawing in Section 3-3.
- ② The panel thickness should be 1.0 to 4.0 mm.
- ③ As the instrument is provided with pawls for fixing, just press it firmly from the front of the panel.
- ④ The SR90 series instrument is designed in a panel-mounting mode. Never use it without mounting on the panel.

3-3. External Dimensions and Panel Cutout

SR91

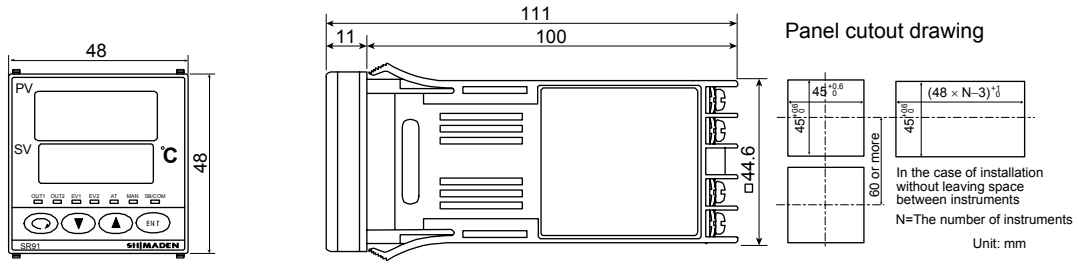

SR92

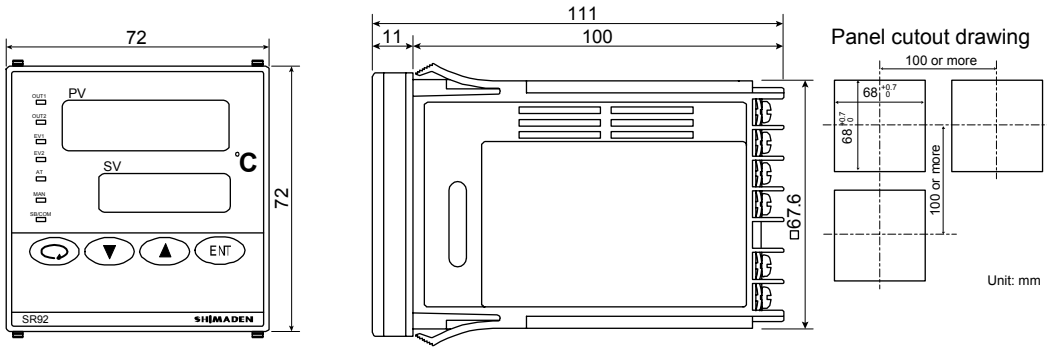

SR93

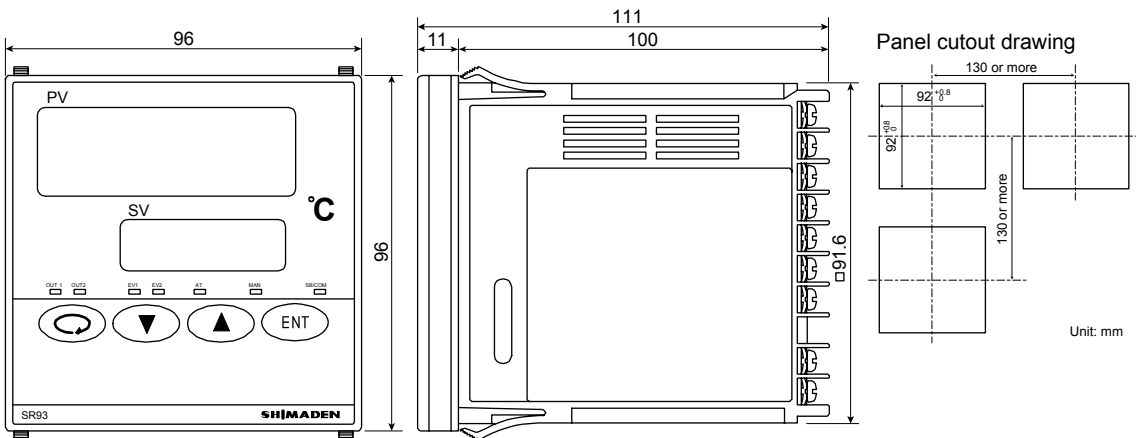

SR94

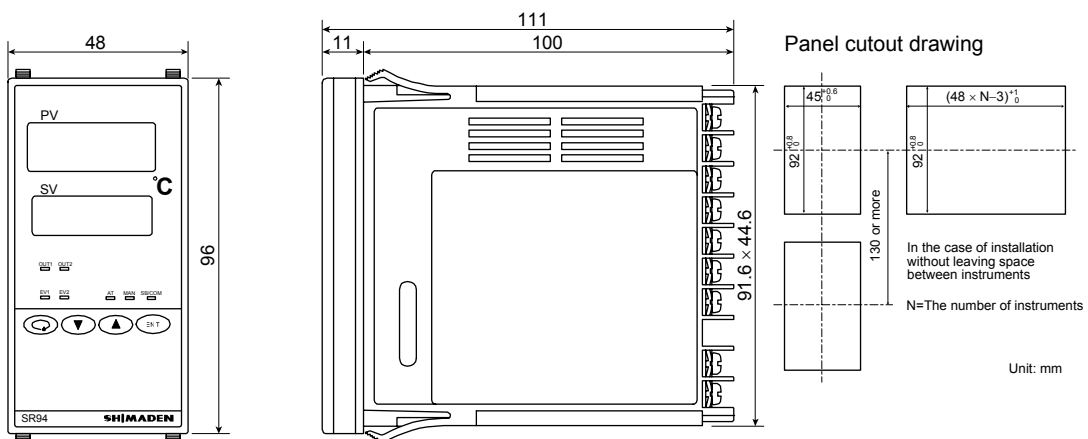

External dimensions of current detectors (CT) of heater break alarm

For 0 to 30 A (CTL-6-S)

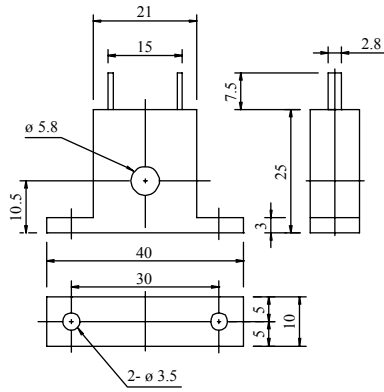

For 0 to 50 A (CTL-12-S36-8)

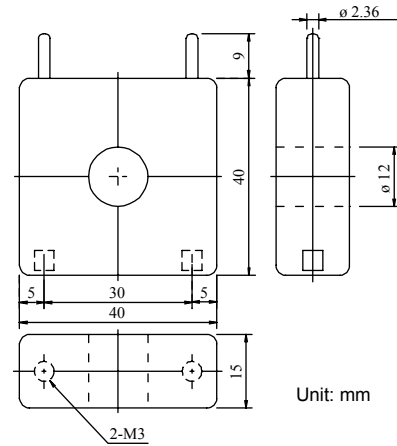

3-4. Wiring

⚠ WARNING

- Make sure to disconnect this product from any power source during the wiring operation to prevent an electric shock.
- Be certain that the protective conductor terminal (⊕) is properly grounded. Otherwise, an electric shock may result.
- Do not touch wired terminals and other charged elements while they are being energized in order to prevent an electric shock.

Please pay attention the following;

- ① In the wiring operation, follow the terminal layout shown in Section 3-5 and the terminal arrangement in Section 3-6 and make sure to carry out the correct wiring process.
- ② Use ring tongue terminals that fit an M3.5 screw and have a width of 7 mm or less.
- ③ In the case of thermocouple input, use a compensating lead wire compatible with the selected type of thermocouple.
- ④ In the case of R.T.D. input, the resistance of a single lead wire must be 5Ω or less and the three wires must have the same resistance.
- ⑤ The input signal wire must not be accommodated with a high-voltage power cable in the same conduit or duct.
- ⑥ Shield wiring (single point grounding) is effective against static induction noise.
- ⑦ Twisting the input wires at short and equal intervals is effective against electromagnetic induction noise.
- ⑧ In wiring for power supply, use a wire or cable whose performance is equal to or higher than the 600V vinyl insulated wire having a sectional area of 1 mm² or larger.
- ⑨ The wire for grounding must have a sectional area of 2 mm² or larger and must be grounded at a grounding resistance of 100Ω or less.
- ⑩ Clamp the screws of terminals firmly. Clamping torque: 1.0 N • m (10 kgf • cm)
- ⑪ If the instrument appears to be easily affected by power supply noise, use a noise filter to prevent malfunctioning. Mount the noise filter on the grounded panel and make the wire connection between the noise filter output and the power line terminals of the controller as short as possible.

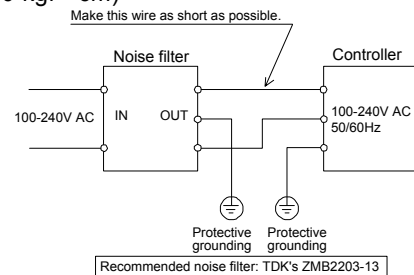

⑫ Connection of current detector (CT)

Insert a load line through the hole of the noise filter meant for the controller. With this wire, connect the secondary side terminal of CT to the CT input terminal of the SR90 series controller.

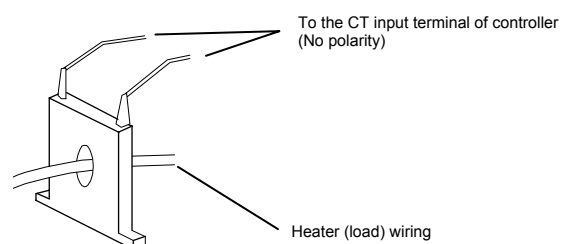

3-5. Terminal Layout

Follow the terminal layout and terminal arrangement table shown below in your wiring operation.

SR91

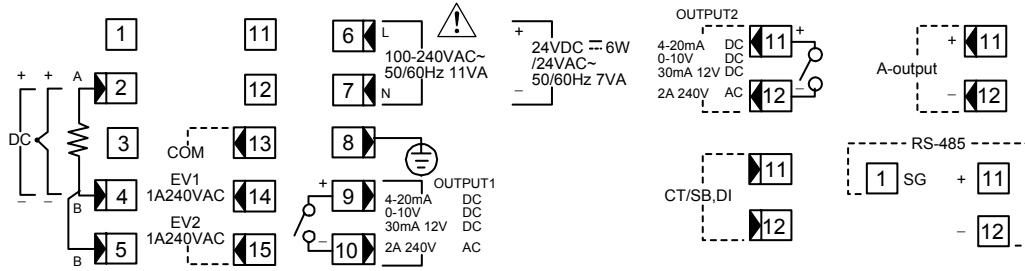

SR92

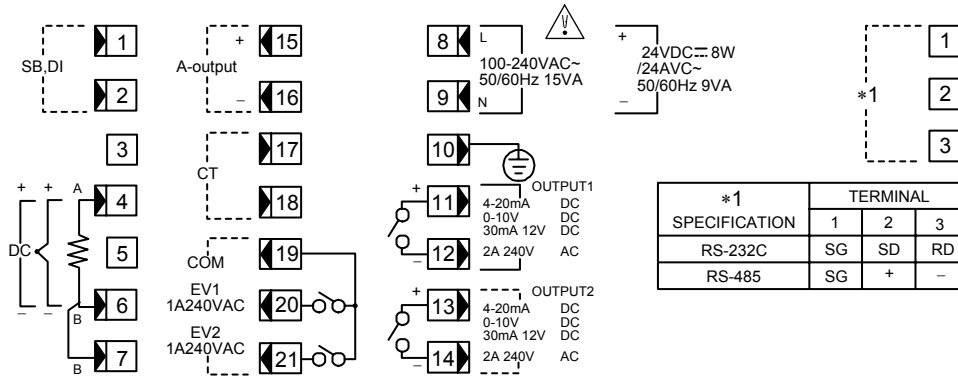

SR93/SR94

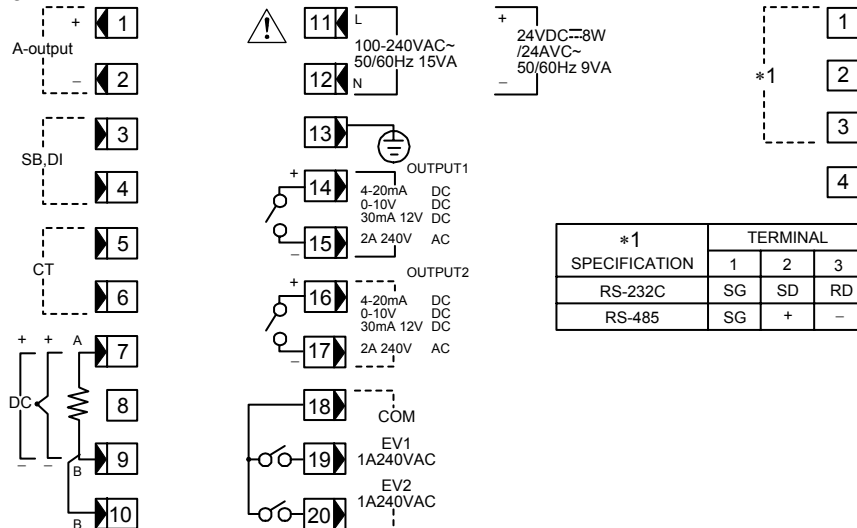

3-6. Terminal Arrangement Table

Name of terminal	Description/Code	Terminal No.		
		SR91	SR92	SR93 • 94
Power supply	100-240V AC/24V AC: L, 24V DC: +	6	8	11
	100-240V AC/24V AC: N, 24V DC: -	7	9	12
Protective conductor	⊕	8	10	13
Input	R.T.D.: A, thermocouple/voltage/current: +	2	4	7
	R.T.D.: B, thermocouple/voltage/current: -	4	6	9
	R.T.D.: B	5	7	10
Control output 1	Contact: NO, SSR drive voltage/Voltage/Current: +	9	11	14
	Contact: NO, SSR drive voltage/Voltage/Current: -	10	12	15
Control output 2 (option)	Contact: NO, SSR drive voltage/Voltage/Current: +	11	13	16
	Contact: NO, SSR drive voltage/Voltage/Current: -	12	14	17
Event output (option)	COM	13	19	18
	EV1	14	20	19
	EV2	15	21	20
Heater break (option)	CT input	11-12	17-18	5-6
Analog output (option)	+	11	15	1
	-	12	16	2
Communication (option)	RS-232C: SD, RS-485: +		2	2
	RS-232C: RD, RS-485: -		3	3
	SG	1	1	1
	RS-485: + RS-485: -	11 12		
DI (option)		11-12	1-2	3-4

NOTE:
With thermocouple/voltage/current input, shorting across B and B terminal will cause an error.

NOTE:
The optional functions of the SR90 are subject to the following conditions:

SR91:
Only one of control output 2, heater break alarm, analog output, communication and DI is selectable.

SR92:
Communication and DI are not selectable simultaneously.

SR93/SR94:
Communication and analog output, or communication and DI are not selectable simultaneously.
Simultaneous selection of analog output and DI is possible, though.

3-7. Before Starting Operation

To begin with, check the wiring and set the items listed below by the setting methods of the screen groups. Factory-set items and items already set by equipment manufacturers need not be set here.

1. Checking of wiring:

Check that the wiring to connected terminals is carried out properly. Erroneous wiring will result in burnout.

2. Application of operating power:

Apply operating power. The controller is energized and the data display and other lamps light.

3. Setting of measuring range:

Call the screen 1-51 (measuring range code screen) of the screen group 1 and select and register a code from the measuring range codes. Call the screen 1-52 (temperature unit setting screen) of the screen group 1 and select and register a temperature unit. For current, voltage or mV input, lower/higher limit values and the position of decimal point should be set on the screen 1-53, 1-54 or 1-55 respectively.

4. Setting of control mode (PID):

In the case of ON-OFF (two-position) control, call the screen 1-2 (output 1 proportional band setting screen) of the screen group 1, select OFF and register it. Call the screen 1-3 (output 1 hysteresis setting screen) of the screen group 1, set and register it.

Follow the same procedure for output 2 if the option is added.

Omit this setting in the case of AT (Auto Tuning).

5. Setting of control output characteristics:

Call the screen 1-45 (control output characteristic setting screen) of the screen group 1 and select either RA (Reverse Action) or DA (Direct Action) correspondingly to output characteristic specification (Heating/Cooling).

6. Setting of event type:

If the optional event function is added, call the screen 1-21 and/or 1-24 (event alarm type code setting screen) of the screen group 1 and select and register a code.

7. Setting of analog output:









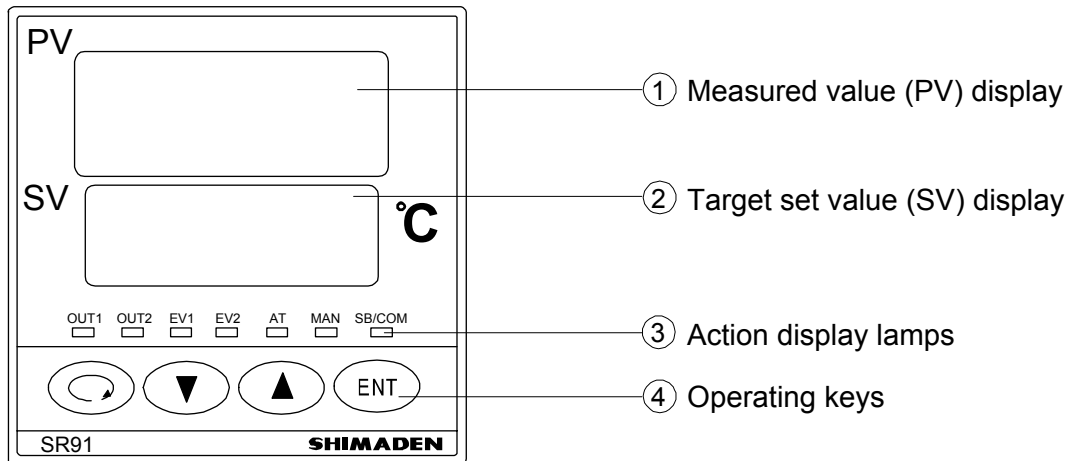



If the optional analog output function is added, call the screen 1-32 (analog output type setting screen) of the screen group 1 and select one from the setting range and register it.

8. Note on initialization following data change:

When the code of measuring range, event type or analog output type is changed, a set value is initialized and resetting is required.

4. Names and Functions of Parts on Front Panel



Name	Function
① Measured value (PV) display:	(1) Present measured value (PV) is displayed on the screen group 0, basic screen and output display screens (OUT1 and OUT2). (red) (2) Type of parameter is shown on each parameter screen. (3) The decimal point at the lowest digit flashes when the controller is in standby (STBY) mode.
② Target set value (SV) display:	(1) Target set value (SV) is displayed on the basic screen of the screen group 0. (green) (2) Present output value is displayed by % on control output monitor screens (OUT1, OUT2) of the screen group 0. (3) Selected item and set value are displayed on each parameter screen.
③ Action display lamps:	(1) Control output indicators: OUT1 and OUT2 (option) (green) - OUT1 lights up when output turns ON and goes out when it turns OFF during contact or SSR drive voltage output. - The brightness changes in proportion to output increase/decrease during current or voltage output. - OUT2 functions only if the option is added. (2) Event output indicators: EV1/EV2 (option) (orange) - Light up when assigned events (including heater break/heater loop alarm) turn ON if event option is added. (3) Auto tuning action indicator: AT (green) - Flashes when ON is selected by  key on the AT action selection screen and AT is executed by  key, and goes out when AT terminates automatically or is released. (4) Manual control output action indicator: MAN (green) - Flashes when manual control output is selected on control output display screens (OUT1, OUT2). Goes out when automatic (PID) control output is executed. (5) Set value bias/communication indicator: SB/COM (option) (green) - Lights up when optional DI function is added, SB (set value bias) is assigned to it, and at the time of shorting across the SB,DI terminal (set value bias in action). - Lights up when optional communication function is added and COM mode is selected. Goes out when Local is selected for communication mode.
④ Operating keys:	(1)  (parameter) key - Pressing this key on any screen of the screen group 0 and the screen group 1 calls the next screen onto display. - When pressed continuously for 3 seconds, this key functions to move between the basic screen of screen group 0 and the initial screen of screen group 1. - Pressing this key simultaneously with  key in the screen group 1 calls the preceding screen onto display. (2)  (down) key - When pressed on a parameter screen, the decimal point at the lowest digit flashes and the set data decreases or moves backward. (3)  (up) key - When pressed on a parameter screen, the decimal point at the lowest digit flashes and the set data increases or moves forward. (4)  (entry/registration) key - Used to register a set data changed by means of  or  key on a parameter screen. - Pressing this key simultaneously with  key on a screen of the screen group 1 calls the preceding screen onto display. - When pressed continuously for 3 seconds on the control output screens (OUT1, OUT2), or pressing  +  key functions to switch between automatic output and manual output.

5. Explanation of Screens and Setting

5-1. Parameter Flow

Outline of Parameter Flow displayed below. Set parameter according to the explanation of each setting screen.

NOTE: Four kinds of frame lines signify the following:

	Screens regularly shown by key operation and other means		Screens which may or may not be shown depending on control action modes (PID action or ON-OFF action)
	Screens shown when appropriate options are added or selected		Screens for monitoring (without automatic return after 3 minutes)

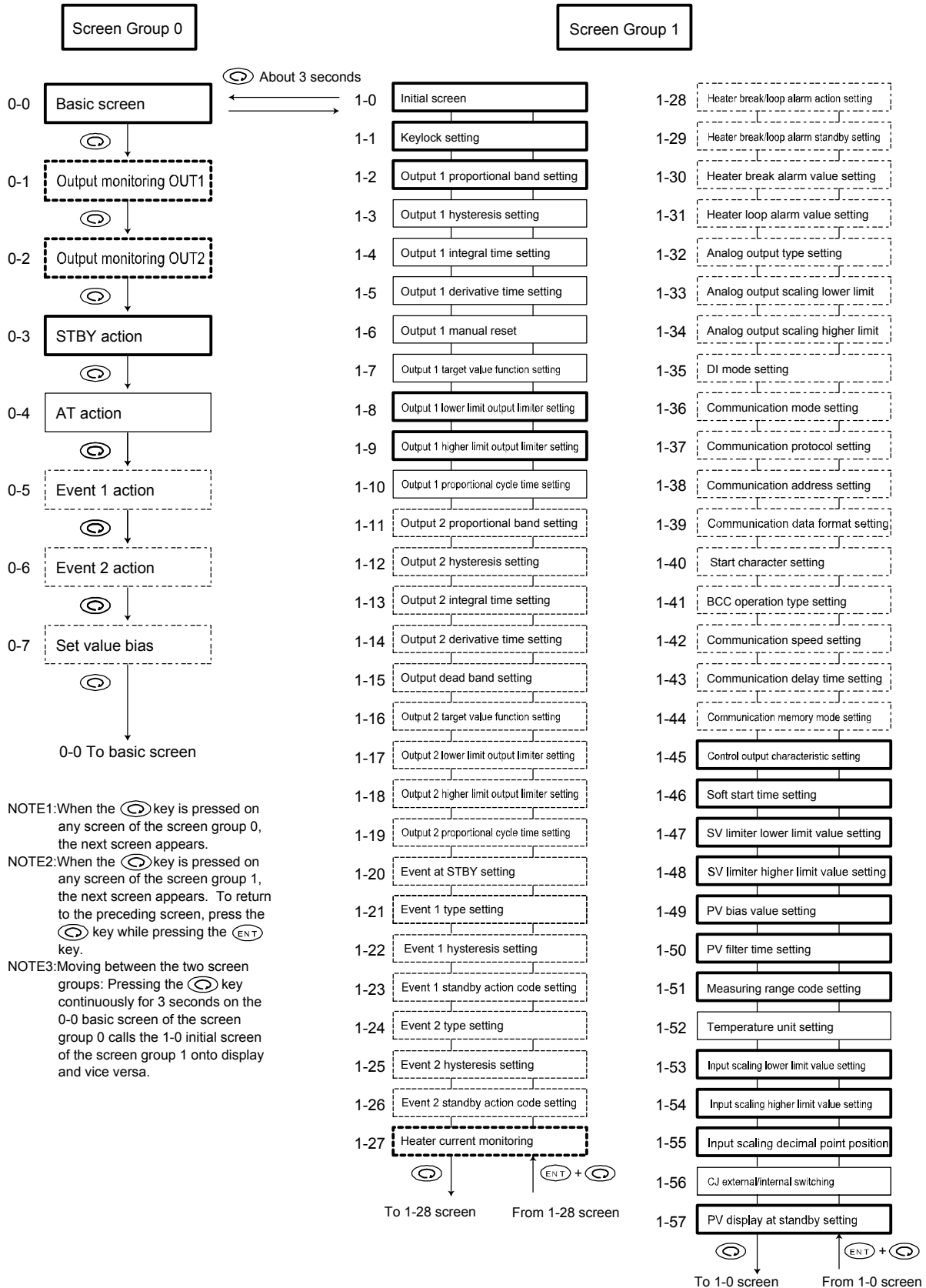

5-2. Display upon Power-ON

When power is applied, initial screens upon power-ON are displayed successively, each for about 1 second. Then the basic screen is displayed.

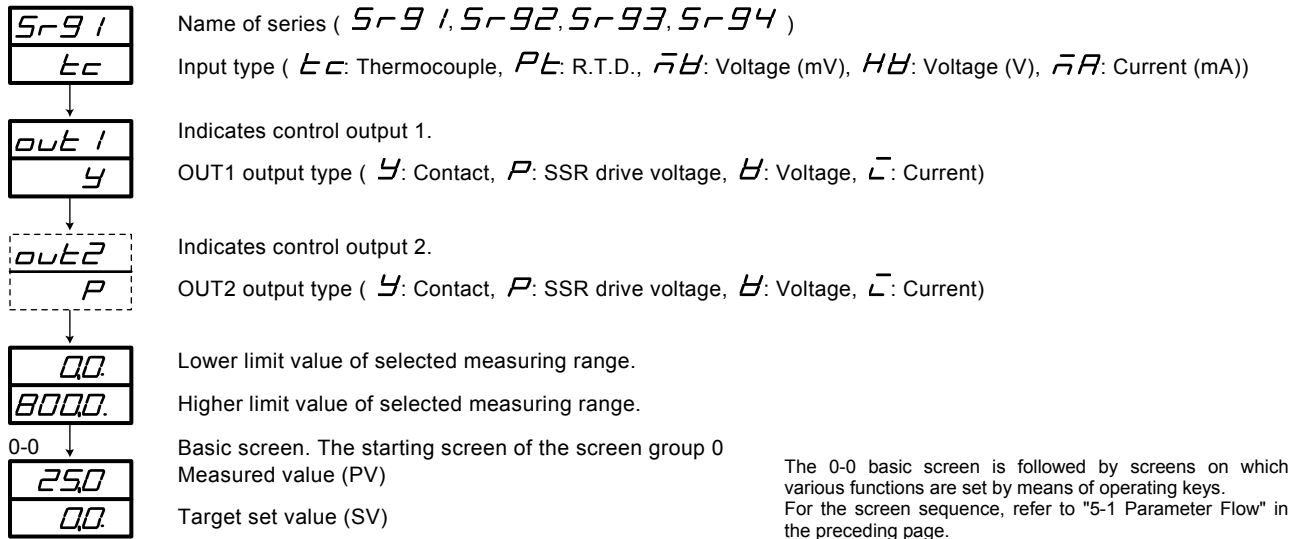

5-3. How to Change Screens

Screen group 0 (the group of screens for setting primarily by the end user)

Screen group 1 (the group of screens for setting primarily by the manufacturer or equipment manufacturers)

(1) How to change screens in screen group 0

Every time the key is pressed, the screen moves to the next and the 0-0 basic screen returns when it is pressed on the last screen.

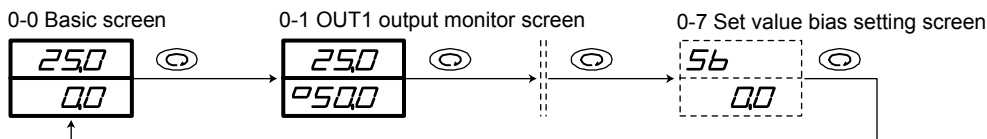

(2) How to change screen group 0 to/from screen group 1

Pressing the key continuously for 3 seconds on the basic screen of the screen group 0 calls the 1-0 initial screen of the screen group 1 onto display.

Also by pressing the key continuously on the 1-0 initial screen of screen group 1 calls the basic screen of screen group 0.

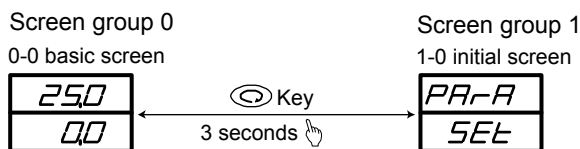

(3) How to change screen in screen group 1

Starting from the 1-0 initial screen of the screen group 1, every time the key is pressed, the next screen appears and the 1-0 initial screen returns when it is pressed on the last screen.

When holding down the key and pressing the key in the screen group 1, you can go back to the preceding screen.

When holding down the key and pressing the key on the 1-0 initial screen, the last screen of this group, i.e., the 1-57 PV display at standby setting screen appears on the display.

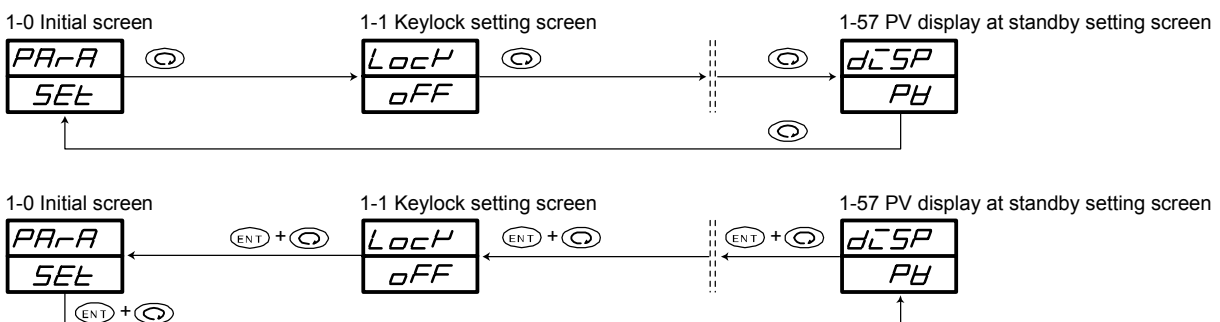

(4) How to change set values (data)

To change data on a screen, use the \blacktriangle or \blacktriangledown key, and register the changed data by pressing the ENT key.

5-4. Auto Return Function

If no key is operated for 3 minutes or longer on a screen (except the 0-1 output 1 monitor screen, 0-2 output 2 monitor screen and 1-27 heater current monitor screen), the screen automatically changes to the 0-0 basic screen of the mode 0 screen group. This is called auto return.

5-5. Procedure of Setting in Screen Group 0

The flow of setting screens is explained in the following section "6. Explanation of Screen Group and Setting". In this section, the procedure of setting is described.

Key operation: Use the ENT key to call the next screen. On each setting screen, use the \blacktriangle or \blacktriangledown key for selection and the ENT key for registration. Nevertheless, in case the value of manual control output is changed on the output monitor screen, the ENT key need not be pressed.

(1) Setting of target set value (SV)

- To set a target set value (SV), press the \blacktriangle or \blacktriangledown key on the 0-0 basic screen. When either of the keys is pressed continuously, the decimal point of the lowermost digit flashes and the numerical value keeps increasing or decreasing. When it reaches a target set value, press the ENT key to register.
- Once it reaches the target set value, the digit stops flashing.
Setting of a target set value is not possible while auto tuning (AT) is in execution. AT should be relieved for setting.

Example: 500.0°C is to be set as a target set value.

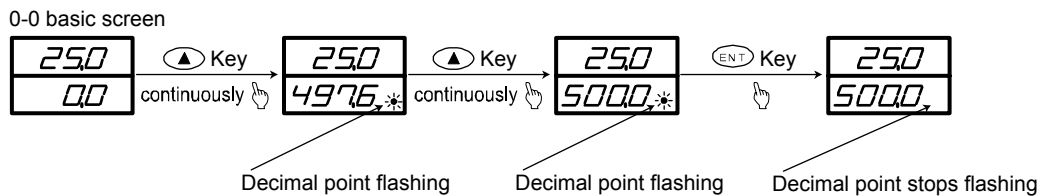

(2) Manual setting of control output

1) Switching between automatic output and manual output on output monitor screen (OUT1 and OUT2) and setting:

To switch auto to manual and vice versa, press the ENT key for 3 seconds continuously, or press the \blacktriangle key while holding the ENT key on the screen 0-1 output 1 monitoring screen or the screen 0-2 output 2 monitoring screen. Upon turning to manual, the MAN lamp flashes and it remains unlighted during automatic output.

To set a target value at manual output, press the \blacktriangle or \blacktriangledown key on the output monitor screen to keep the numerical value increasing or decreasing until a target value is reached.

To release manual output, press the ENT key for 3 seconds continuously, or press the \blacktriangle key while holding the ENT key, and automatic output returns.

- If the output mode of either output 1 or output 2 is changed to manual, the output mode of the other is also changed to manual. Also, if changed to auto, the output of the other will be changed to auto as well.
- In case the output of output 1 is at 100.0%, 0999 is displayed on the output 1 screen and the decimal point of 0 flashes.
- In case the output of output 2 is at 100.0%, 0999 is displayed on the output 2 screen and the decimal point of 0 flashes.
- In case output is of contact or SSR drive voltage and OFF is set for proportional band (P), the value of output will be 0.0% or 100.0%.
- In case output is of voltage or current and OFF is set for proportional band (P), the value of output will be the lower limit value or the higher limit value of a set output limiter.

While auto tuning (AT) is in execution, switching to manual output is not possible. It should be done after releasing AT.

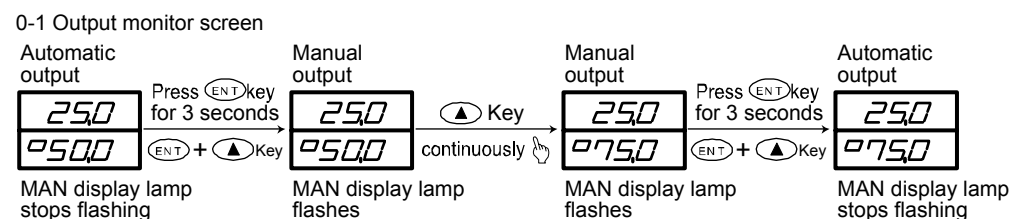

2) Supplementary explanation of using the manual control output

Monitor screens (OUT1 and OUT2) and automatic/manual output:

- ① When automatic output is changed to manual, balanceless/bumpless transfer is provided, and the value of output right before the change is displayed. Changing from manual to auto also provides balanceless/bumpless transfer, but not if the PV value is outside the proportional band.
- ② If power supply is shut off and power is applied again, control output continues to be in auto or manual at the time when power supply is shut off.

NOTE: Although a change to another screen in the manual mode is possible, it should be noted that control output is manual in this case. Flashing of the MAN monitor LED indicates that the manual mode is ON.

- ③ Manual output is released when one of the following parameters is changed:
Range, unit, or higher/lower limit of scaling

(3) AT (auto tuning)

AT is the function of automatically computing and setting P.I.D. value, the parameters of P.I.D. control. Computing time differs depending on the details of control.

1) Execution of AT

Pressing the \blacktriangle key on the 0-4 AT action control screen, change *OFF* displayed on the bottom to *ON* and the decimal point of the lowermost digit flashes. Then press the ENT key. The decimal point stops flashing, the AT lamp flashes and AT starts.

When AT is executed, ON-OFF action of output in response to rising and falling of the measured value from the target set value is repeated several times to store PID values internally and AT ends. At the same time control using stored PID values begins and the AT lamp goes out.

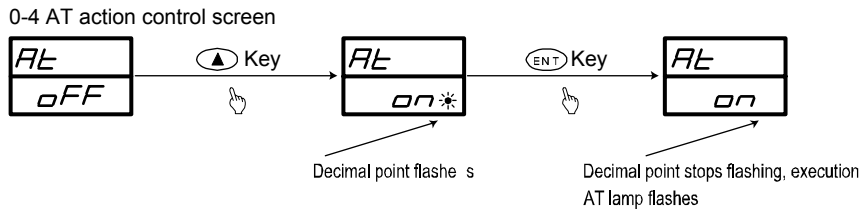

2) Stop of AT

To stop AT in the middle of execution, select *OFF* by using the \blacktriangledown key on the 0-4 AT action control screen and by pressing the ENT key, releases the AT and the decimal point and the AT lamp stops flashing.

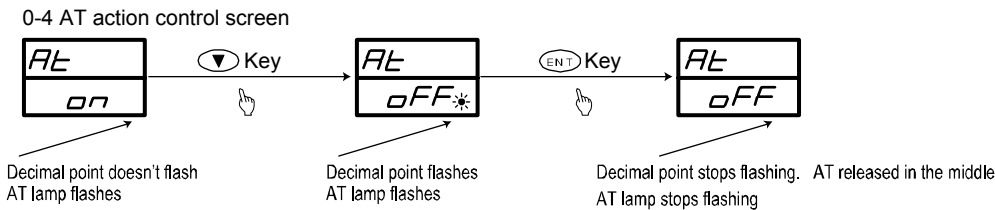

NOTE: In case AT is released in the middle, PID values are not changed.

3) Unexecutable conditions of AT

In the following conditions, AT is unable to be executed:

- ① Control output is in manual. (The AT screen is not displayed.)
- ② Under STBY mode. (The AT screen is not displayed.)
- ③ Scaleover of PV (measured value). (The AT screen is not displayed.)
- ④ OFF is selected for proportional band (P) of output 1. (The AT screen is not displayed.)
- ⑤ Lock No. 2 or 3 is selected on the keylock screen.

4) Automatic stop conditions of AT

If any of the following occur while AT is in execution, AT will be released:

- ① The output value has been at 0% or 100% continuously for 200 minutes.
- ② Scaleover of PV value
- ③ The control execution is changed to standby.

5) AT action in two-output specification

AT works as follows up to the RA or DA characteristic in the two-output specifications:

- ① RA characteristic: PID constants are common to OUT1 and OUT2.
- ② DA characteristic: AT is executed only for OUT1. While AT is in execution, output of OUT2 is at 0% or the lower limit value of output limiter.

(4) Standby mode (STBY)

1) What is standby mode?

This instrument supports standby mode (STBY), which stops the control operation temporarily.

Switching to/from execution/STBY can be set on the 0-3 STBY action control screen.

When STBY is assigned to DI (external input) on the 1-35 DI mode setting screen, the setting on the screen 0-3 cannot be performed, as DI setting is preferred.

- ① During STBY, the decimal point of the lowermost digit on the PV display flashes.
- ② The output value is 0% during STBY.
- ③ When STBY is selected, AT (auto tuning) is stopped.
- ④ When STBY is selected in manual control, manual control is released.
- ⑤ If the power supply is shut off in STBY and power is applied again, STBY is still selected.
- ⑥ During STBY, event output can be set at enable or disable.
- ⑦ If set, event standby action can be executed when the instrument is switched from standby (STBY ON) to execution (STBY OFF).

2) Event at standby

Event can be set enable or disable on the 1-20 event at STBY setting screen.

OFF
ON

Event output disabled (except for status).

Event output enabled when the specified condition is satisfied.

Note that event isn't output in case control mode is selected for event standby action (Code 4 on the screen 1-23 or 1-26).

If *So* or *Hb* is assigned to event type, the event is output even if it is in STBY.

3) PV display at standby

PV display at standby can be set on the 1-57 PV display at standby setting screen.

PH

During STBY, PV value is displayed on the basic screen and the output monitoring screen.

STBY

During STBY, the characters "STBY" are displayed instead of the PV value on the basic screen and the output monitoring screen.

(5) Setting of event set value

Before a value is set, an event type should be set as described in the following paragraph, "1) Event type setting". When an event type code is changed, however, all the set values (data) concerning the event are initialized.

1) Event type (alarm type) setting

Call the 1-21 event 1 type code setting screen (or the 1-24 for event 2) of the screen group 1 and select one from the type codes Hd, Ld, od, id, HA and LA by pressing the \blacktriangle or \blacktriangledown key. Then register it by the ENT key.

There are the following 6 event type (alarm type) codes:

<i>Hd</i>	Higher limit deviation	<i>Ld</i>	Lower limit deviation	<i>od</i>	Outside higher/lower limit deviations
<i>id</i>	Within higher/lower limit deviations	<i>HA</i>	Higher limit absolute value	<i>LA</i>	Lower limit absolute value

oFF: None, *So*: Scaleover, and *Hb*: Heater break/loop alarm are screen display only.

2) Setting of event value

The 0-5 event 1 set value setting screen or the 0-6 event 2 set value setting screen will set. The screen will be displayed when either of the previous 6 types of event is selected.

Set the aimed value by pressing the \blacktriangle or \blacktriangledown key on screen (setting range is described below). When the ENT key is pressed to register the set event value, the decimal point stops flashing.

Setting ranges: Higher limit deviation value or lower limit deviation value: -1999 to 2000 units
 Outside or within higher/lower limit deviation values: 0 to 2000 units
 Higher limit absolute value or lower limit absolute value: Within measuring range

No event value can be set while AT (auto tuning) is in execution. Set after releasing AT.

0-5 Event 1 set value screen

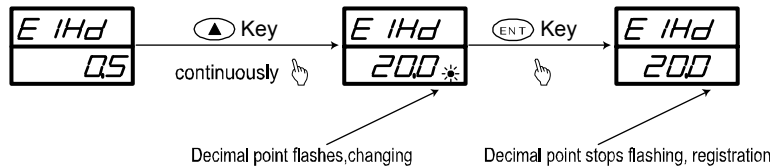

(6) Set value bias

1) Set value bias

As an optional function, additional setting of another target set value is possible.

It is set as a set value bias which indicates a deviation from the target set value.

For instance, when 20°C has been set as the target set and you want to set another set value at 30°C, set the set value bias at +10°C.

The set value bias becomes effective when the SB,DI terminals are shorting.

When the SB,DI terminals are not shorting, the set value bias is not effective.

This function is used conveniently to switch a target value between "summer and winter"/"day and night" and the like.

2) Setting of set value bias

In case the optional DI function is added, press the \blacktriangle or \blacktriangledown key on the screen 0-7 to set a numerical value of set value bias and register the value by pressing the ENT key.

The decimal point stops flashing.

The set value remains effective while the SB,DI terminals are shorting and is added/subtracted to/from the target set value. When a set value bias is set and it is effective, the SB/COM lamp lights.

Setting range: -1999 to 5000 units

6. Explanation of Screen Group and Setting

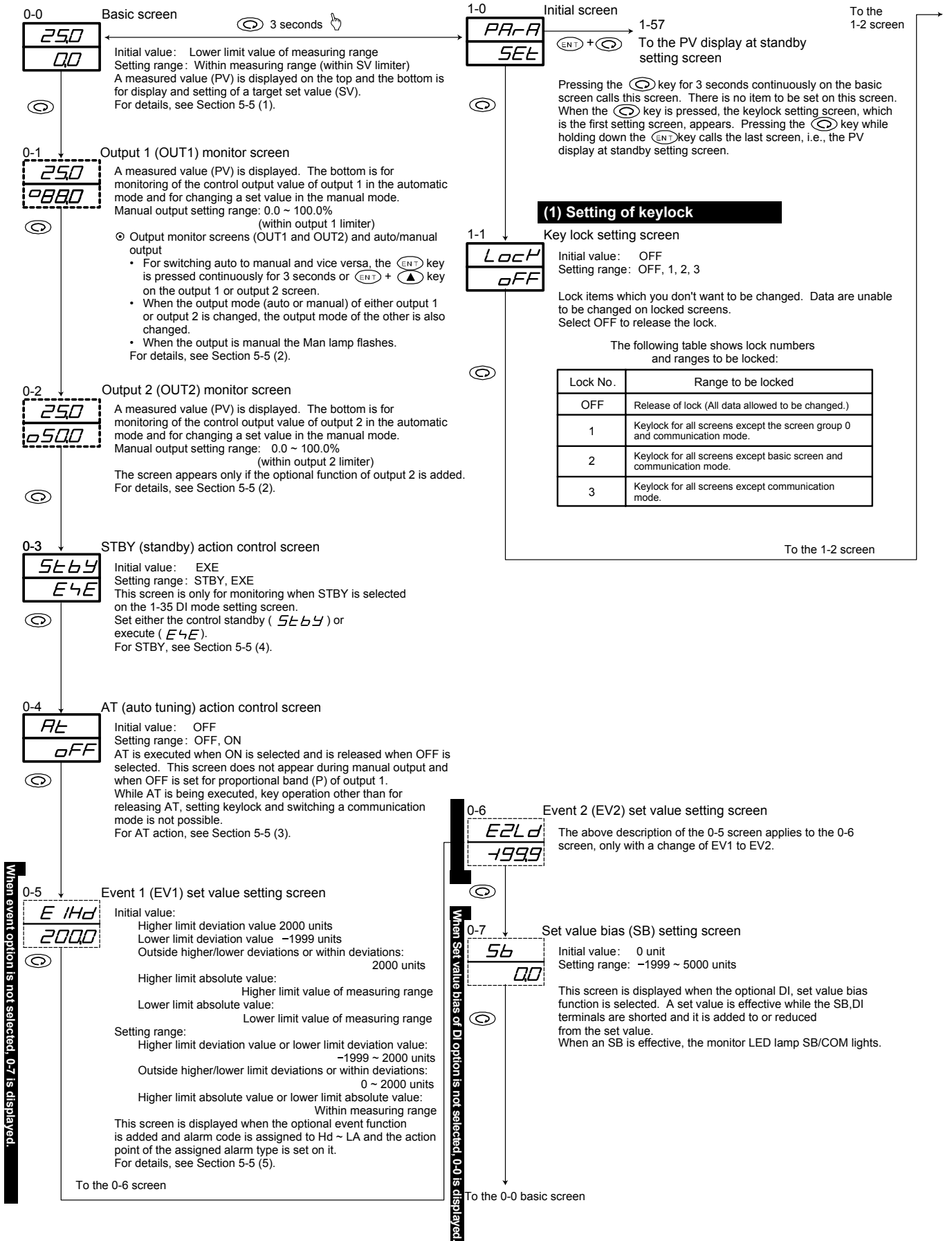

(2) Setting of output

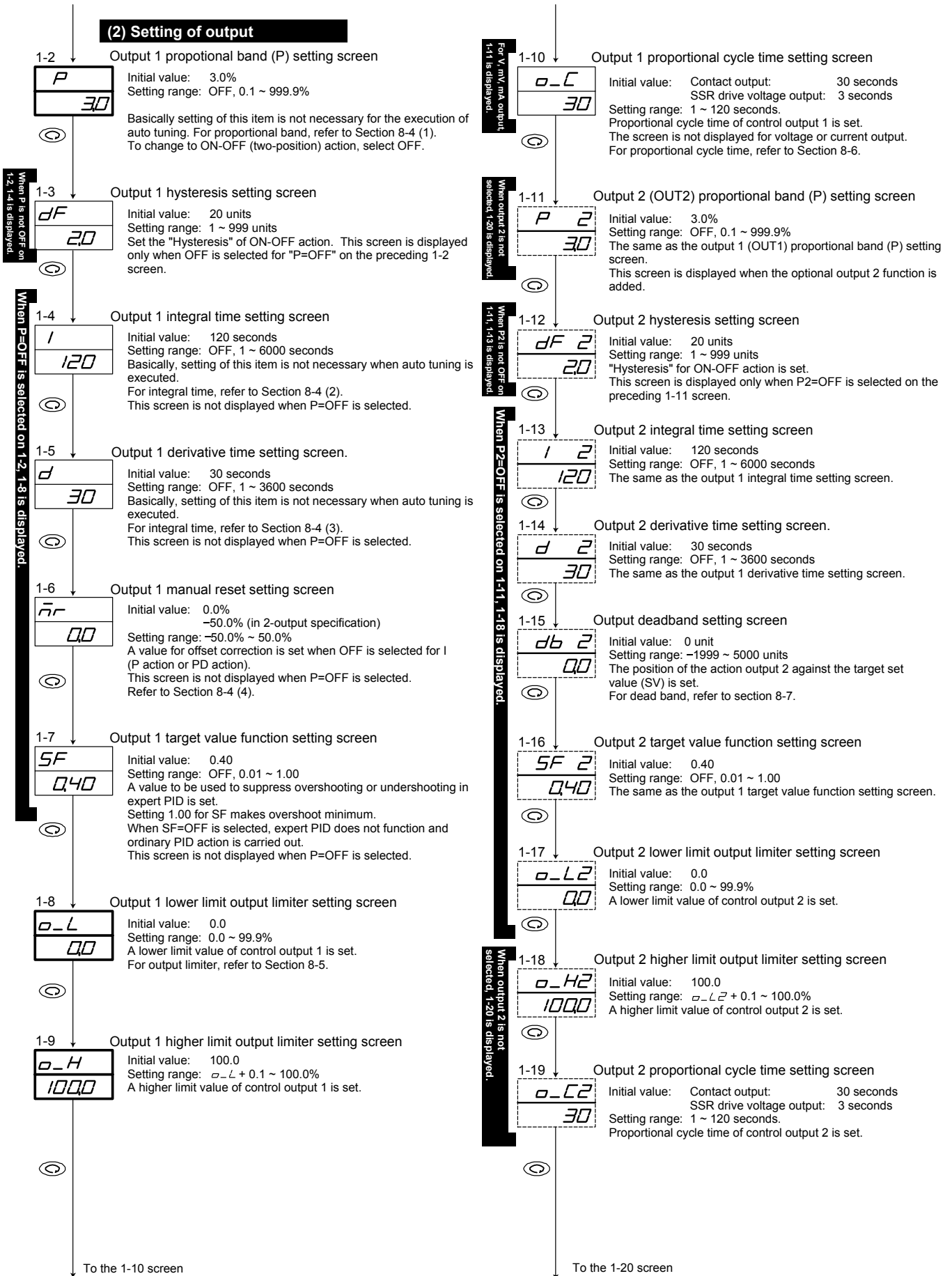

(3) Setting of events

Please refer to section 8-1, 8-2 and 8-3.

1-20 Event at STBY setting screen

Initial value OFF
 Setting range OFF, ON
 Set whether specified event is enabled or disabled during standby. For details, refer to Section 5-5 (4).

1-21 Event 1 type code setting screen

Initial value Hd
 Setting range OFF, Hd, Ld, od, id, HA, LA, So, Hb
 The type of event to be selected as event 1 is selected from the following code table.

Table of Event Type (Alarm Type) Codes

Code	Type of event	Remarks
oFF	No selection	
Hd	Higher limit deviation	Initial value of event 1
Ld	Lower limit deviation	Initial value of event 2
od	Outside higher/lower limit deviations	
cd	Within higher/lower limit deviations	
HA	Higher limit absolute value	
LA	Lower limit absolute value	
So	Scaleover	Standby action is invalid.
Hb	Heater break/loop alarm	Displayed only when the option is added.

1-22 Event 1 hysteresis setting screen

Initial value 5 units
 Setting range 1 ~ 999 units
 ON-OFF hysteresis is set for event 1.
 This screen is displayed when an alarm type code is selected from Hd, Ld, od, cd, HA, LA.

1-23 Event 1 standby action code setting screen

Initial value 1
 Setting range 1, 2, 3, 4
 An event 1 standby action type code is selected from the following table.
 This screen is displayed when an alarm type code is selected from Hd, Ld, od, cd, HA, LA.

Table of Standby Action Codes

Code	Description
1	Without standby function
2	Standby action when power is applied or when STBY is switched ON to OFF.
3	Standby action when power is applied, or when STBY is switched ON to OFF, or when SV in execution is changed.
4	Control mode (without standby)

1-24 Event 2 type code setting screen

Initial value Ld
 Setting range OFF, Hd, Ld, od, id, HA, LA, So, Hb
 The type of alarm to be selected as event 2 is selected from the table of codes.

1-25 Event 2 hysteresis setting screen

Initial value 5 units
 Setting range 1 ~ 999 units
 ON-OFF hysteresis is set for event 2.
 This screen is displayed when an alarm type code is selected from Hd, Ld, od, cd, HA, LA.

1-26 Event 2 standby action code setting screen

Initial value 1
 Setting range 1, 2, 3, 4
 An event 2 standby action type code is selected from the following table.
 This screen is displayed when an alarm type code is selected from Hd, Ld, od, cd, HA, LA.

To the 1-27 screen

(4) Setting of Heater break/loop alarm

1-27 Heater current monitor screen

This screen is displayed when the optional heater break/loop alarm function is added and used to monitor heater current. (There is no item to be set on this screen.)
 --- is displayed when stable current value has not been gained.

NOTE:
 Heater break/loop alarm works on output 1.
 Heater break/loop alarm is selectable as event 1 or event 2.
 Heater break/loop alarm is assignable in case output 1 is of contact or SSR drive voltage.

As this screen is for monitoring only, auto return does not function.

1-28 Heater break/loop alarm action setting screen

Initial value: Lc
 Setting range: Lc, rE

Lc (Lock mode)
 In this mode, once a break or loop alarm is output, the alarm output is maintained until OFF is selected on the heater break or loop alarm value setting screen or the power supply is cut.

rE (Real mode)
 An alarm is turned ON or OFF according to a rise or fall of the value of current from a set value. The hysteresis for the release of alarm output is fixed to 0.2A.

1-29 Heater break/loop standby action setting screen

Initial value OFF
 Setting range OFF, ON
 When ON is set, alarm output is withheld or kept to be on standby until the current value enters its normal range once even if the current at the time of applying power is such that an alarm should be output.

1-30 Heater break alarm value setting screen

Initial value OFF
 Setting range OFF, 0.1 ~ 50.0A
 Heater current is detected by CT while control output is ON. Lower current than a set value of current is taken as abnormal and an alarm is output.

1-31 Heater loop alarm value setting screen

Initial value OFF
 Setting range OFF, 0.1 ~ 50.0A
 Heater current is detected by CT while control output is OFF. Higher current than a set value of current is taken as abnormal and an alarm is output.

(5) Setting of analog output type

1-32 Analog output type setting screen

Initial value: PB
 Setting range PB, SV, out 1, out 2
 An item intended to be output as an analog signal is selected from 4 items: Measured value (PV), target set value (SV), control output 1 (OUT1) and control output 2 (OUT2).

1-33 Analog output scaling lower limit setting screen

Initial value 0.0 (The lower limit value of setting range for PV and SV. 0.0 for OUT1 and OUT2.)
 Setting range Within measuring range when PV/SV is selected. 0.0 ~ 100.0% when OUT1 or OUT2 is selected.
 A minimum value (0mV, 4mA or 0V) of analog output signal is set as the lower limit value of scaling for an intended output value.

To the 1-34 screen

When analog output option is not selected, 1-35 is displayed.

1-34 Analog output scaling higher limit setting screen

Ao_H
8000

Initial value: 800.0 (The higher limit value of setting range for PV/SV and 100.0 for OUT1 and OUT2.)
Setting range: Within measuring range when PV or SV is selected. 0.0 ~ 100.0% when OUT1 or OUT2 is selected.)
A maximum level (10mV, 20mA or 10V) of analog output signal is set as the higher limit value of scaling for an intended output value.
Reverse scaling (Ao_L>Ao_H) is also possible. (H-L = ±1 count or above)

The following diagrams show analog output characteristics by scaling:
In the case of Ao_L<Ao_H In the case of Ao_L>Ao_H

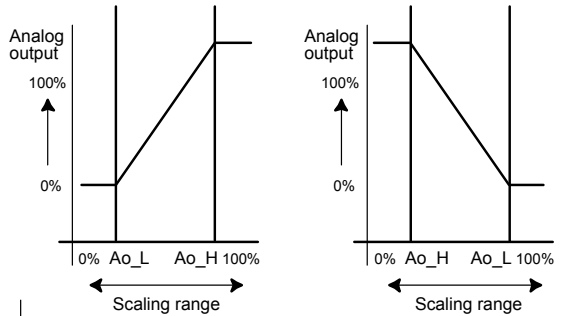

(6) Setting of DI

When DI output option is not selected, 1-36 is displayed.

1-35 DI mode setting screen

dI
5b

Initial value: SB
Setting range: NON, SB, STBY, ACT
External input (DI) type is set in accordance with the intended use.
For DI, refer to Section 8-8.

(7) Setting of communication

For the communication function, refer to the Communication Instruction Manual provided separately.

When communication option is not selected, 1-45 is displayed.

1-36 Communication mode setting screen

com
Loc

Initial value: Loc (local)
Setting range: Loc, Com (com)
Only a change from Com to Loc is possible by operating keys.
Communication is enabled in the mode displayed on the bottom.

1-37 Communication protocol setting screen

Prot
Shc

Initial value: Shim
Setting range: Shim (Shimaden protocol), asc (MODBUS ASCII protocol), rtu (MODBUS RTU protocol)
A communication protocol is set.

1-38 Communication address setting screen

Addr
1

Initial value: 1
Setting range: 1 ~ 255
A machine number is set in case two or more controllers are connected through communication.

1-39 Communication data format setting screen

dAtA
7E1

Initial value: 7E1
Setting range: 7E1, 7E2, 7N1, 7N2, 8E1, 8E2, 8N1, 8N2
A communication data format is set.

Code	Data length	Parity	Stop bit	Shimaden	ASCII	RTU
7E1	7 bits	Even	1 bit	○	○	—
7E2	7 bits	Even	2 bits	○	○	—
7N1	7 bits	None	1 bit	○	○	—
7N2	7 bits	None	2 bits	○	○	—
8E1	8 bits	Even	1 bit	○	—	○
8E2	8 bits	Even	2 bits	○	—	○
8N1	8 bits	None	1 bit	○	—	○
8N2	8 bits	None	2 bits	○	—	○

○ Support
— Not Support

To the 1-40 screen

1-40 Start character setting screen

SchA
5t4

Initial value: 5t4
Setting range: 5t4, At@
Which of 5t4 (STX) and At@ (@) is used as the start character of communication format is set.
This is used for Shimaden protocol only.

1-41 BCC operation type setting screen

bcc
1

Initial value: 1
Setting range: 1, 2, 3, 4
An operation type for error detection BCC check is set from 1 to 4 shown in the following table:
This is used for Shimaden protocol only.

Table of BCC Operation Types

Type of Operation	Description
1	Add operation from start character to text end character
2	2's complement after add operation from start character to text end character
3	Exclusive OR operation immediately after start character to text end character
4	Without BCC operation

1-42 Communication speed setting screen

bPS
1200

Initial value: 1200
Setting range: 1200, 2400, 4800, 9600, 19200 bps
A communication speed is set but 19200 bps is displayed as 1920 because of limitation in the number of digits.

1-43 Communication delay time setting screen

dELY
20

Initial value: 20
Setting range: 1 ~ 100
Time lag from receiving a communication command to transmission is set.
Delay time = Set value × 0.512 msec

1-44 Communication memory mode setting screen

rEA
EEP

Initial value: EEP
Setting range: EEP, rA, r_E
A mode of writing data in EEPROM and RAM in communication is set.

Type	Writing Process
EEP	Writing entirely in EEPROM
rA	Writing entirely in RAM
r_E	Writing OUT1 and OUT2 in RAM and others in EEPROM

To the 1-45 screen

(8) Setting of control output characteristic

1-45 Control output characteristic setting screen

Initial value: *rA*
 Setting range: *rA, dA*

Characteristic of control output is set.
 In case the set value of the 1-35 DI mode setting screen is ACT, this screen is only for display.
 The following table shows output characteristics of the one-output specification and the two-output specification.

Output specification	Characteristic	OUT 1	OUT 2
1-output	RA	Heating	None
	DA	Cooling	None
2-output	RA	Heating	Cooling
	DA	Heating	Heating

For control output characteristic, refer to Section 8-7.

(9) Setting of soft start time

1-46 Soft start setting screen

Initial value: OFF
 Setting range: OFF, 1 ~ 100 seconds

Soft start time for changing output gradually is set.
 Soft start does not function when OFF is set.
 For details, see Section 8-9.

(10) Setting of SV limiter

1-47 SV limiter lower limit value setting screen

Initial value: Lower limit value of measuring range
 Setting range: Measuring range lower limit value ~ higher limit value - 1 count

In case a narrower setting range of target value than a measuring range is used, a lower limit value is set. (It can prevent erroneous setting in a risky range and has some other advantageous effect.)

1-48 SV limiter higher limit value setting screen

Initial value: Higher limit value of measuring range
 Setting range: Measuring range lower limit value ~ higher limit value + 1 count

In case a narrower setting range of target value than a measuring range is used, a higher limit value is set. (It can prevent erroneous setting in a risky range and has other advantageous effect.)

NOTE:
 An SV limiter is set so as to be SV limiter lower limit value < SV limiter higher limit and priority is given to the lower limit value. Therefore, a higher limit cannot be set at a smaller value than a lower limit value + 1 count.

The setting value of Sc_L and Sc_H overwrite SV_L and SV_H value respectively as they are given priority over SV_L and SV_H.

(11) Setting of PV bias value

1-49 PV bias value setting screen

Initial value: 0 unit
 Setting range: -1999 ~ 2000 units

This value is used to correct an input error from a sensor or the like.
 When a bias is used, control is also carried out with a corrected value.

(12) Setting of PV filter time

1-50 PV filter time setting screen

Initial value: 0 second
 Setting range: 0 ~ 100 seconds

In case input changes conspicuously or noise continues, PV filter is used to mitigate such undesirable effect.
 When 0 second is set, filter does not function.

To the 1-51 screen

(13) Setting of measuring range code

1-51 Measuring range code setting screen

Initial value: Universal 05, voltage 86, current 92
 Setting range: Select from the Table of Measuring Range Codes in Section 7.

Each code represents a combination of an input type and a measuring range.

(14) Setting of temperature unit

1-52 Temperature unit setting screen

Initial value: C
 Setting range: C, F

Select C (°C) or F (°F) as the unit of temperature for sensor input.
 This screen is not displayed when linear input (mV, V or mA) is selected.

(15) Setting of input scaling

1-53 Input scaling lower limit value setting screen

Initial value: 0.0
 Setting range: -1999 ~ 9989 units

A lower limit value of scaling of linear input (mV, V or mA) is set.
 For sensor input, the screen is for monitoring only and setting is not possible.

1-54 Input scaling higher limit value setting screen

Initial value: 100.0
 Setting range: Sc_L + 10 ~ Sc_L + 5000

A higher limit value of scaling of linear input (mV, V or mA) is set.
 For sensor input, the screen is for monitoring only and setting is not possible.

NOTE:
 If input scaling higher/lower limits is set to make difference between the higher and lower limit values less than +10 counts or more than +5000 counts, the higher limit value is automatically changed to make the difference +10 counts or +5000 counts.
 A higher limit value which is smaller than a lower limit value +10 counts or larger than a lower limit value +5000 counts is unable to be set.

1-55 Input scaling decimal point position setting screen

Initial value: One decimal place (0.0)
 Setting range: No decimal place (0) ~ 3 decimal places (0.000)

The position of decimal point for input scaling is set.
 For sensor input, this screen is for monitoring only and setting is not possible.

(16) Setting of CJ (Cold Junction)

1-56 CJ external/internal switching setting screen

Initial value: *Int*
 Setting range: *Int, Ext*

Switch the use of thermocouple's CJ internally or externally.
Int Internal CJ *Ext* External CJ
 This screen is displayed when thermocouple input is selected.

(17) Setting of PV display at STBY

1-57 PV display at standby setting screen

Initial value: *PB*
 Setting range: *PB, Stby*

Set whether or not PV value is displayed.
PB PV value is displayed.
Stby The character "Stby" is displayed instead of PV value.

When TC input is not specified, 1-57 is displayed.

ENT +

From the 1-0 initial screen of the screen group 1

To the 1-0 initial screen of the screen group 1

7. Table of Measuring Range Codes

Select a measuring range from the following table.

A change of the code will initialize all data related to the measuring range.

Input type		Code	Measuring range (°C)	Measuring range (°F)	
Universal Input	Thermocouple	B *1	01	0 ~ 1800	0 ~ 3300
		R	02	0 ~ 1700	0 ~ 3100
		S	03	0 ~ 1700	0 ~ 3100
		K	04 *2	-199.9 ~ 400.0	-300 ~ 750
			05	0.0 ~ 800.0	0 ~ 1500
			06	0 ~ 1200	0 ~ 2200
		E	07	0 ~ 700	0 ~ 1300
		J	08	0 ~ 600	0 ~ 1100
		T	09 *2	-199.9 ~ 200.0	-300 ~ 400
		N	10	0 ~ 1300	0 ~ 2300
		PL II	11	0 ~ 1300	0 ~ 2300
		WRe5-26	12	0 ~ 2300	0 ~ 4200
	U *5	13 *2	-199.9 ~ 200.0	-300 ~ 400	
	L *5	14	0 ~ 600	0 ~ 1100	
	Kelvin	K	15 *6	10.0 ~ 350.0 K	10.0 ~ 350.0 K
		AuFe-Cr	16 *7	0.0 ~ 350.0 K	0.0 ~ 350.0 K
		K	17 *6	10 ~ 350 K	10 ~ 350 K
		AuFe-Cr	18 *7	0 ~ 350 K	0 ~ 350 K
R.T.D.	Pt100	31	-200 ~ 600	-300 ~ 1100	
		32	-100.0 ~ 100.0	-150.0 ~ 200.0	
		33	-50.0 ~ 50.0	-50.0 ~ 120.0	
		34	0.0 ~ 200.0	0.0 ~ 400.0	
	JPt100	35	-200 ~ 500	-300 ~ 1000	
		36	-100.0 ~ 100.0	-150.0 ~ 200.0	
		37	-50.0 ~ 50.0	-50.0 ~ 120.0	
		38	0.0 ~ 200.0	0.0 ~ 400.0	
mV	-10 ~ 10mV	71	Initial value: 0.0 ~ 100.0 Input scaling setting range: -1999 ~ 9999 Span: 10 ~ 5000 counts Position of decimal point: None 1, 2 or 3 decimal places Lower limit value < higher limit value		
	0 ~ 10mV	72			
	0 ~ 20mV	73			
	0 ~ 50mV	74			
	10 ~ 50mV	75			
	0 ~ 100mV	76			
Voltage	V	-1 ~ 1V	81	Initial value: 0.0 ~ 100.0 Input scaling setting range: -1999 ~ 9999 Span: 10 ~ 5000 counts Position of decimal point: None 1, 2 or 3 decimal places Lower limit value < higher limit value	
		0 ~ 1V	82		
		0 ~ 2V	83		
		0 ~ 5V	84		
		1 ~ 5V	85		
		0 ~ 10V	86		
Current	mA	0 ~ 20mA	91		
		4 ~ 20mA	92		

Thermocouple: B, R, S, K, E, J, T, N: JIS/IEC

R.T.D.: Pt100: JIS/IEC, JPt100: Former JIS

*1 Thermocouple B: Accuracy guarantee not applicable to 400°C (752°F) and below.

*2 Thermocouple K, T, U: Accuracy of those whose readings are below -100°C is ±0.7% FS

*3 Thermocouple PLII: PlatineI

*4 Thermocouple WRe5-26: ASTM E988-96 (Reapproved 2002)

*5 Thermocouple U, L: DIN 43710

*6 Thermocouple K: Accuracy is as follows;

*7 Thermocouple AuFe-Cr: Accuracy is as follows;

Temperature range External CJ Internal CJ

Temperature range External CJ Internal CJ

10.0 ~ 30.0 K ±(2.0%FS + (CJ error x 20)K + 1K)

0.0 ~ 30.0 K ±(0.7%FS + (CJ error x 3)K + 1K)

30.0 ~ 70.0 K ±(1.0%FS + (CJ error x 7)K + 1K)

30.0 ~ 70.0 K ±(0.5%FS + (CJ error x 1.5)K + 1K)

70.0 ~ 170.0 K ±(0.7%FS + (CJ error x 3)K + 1K)

70.0 ~ 170.0 K ±(0.3%FS + (CJ error x 1.2)K + 1K)

170.0 ~ 270.0 K ±(0.5%FS + (CJ error x 1.5)K + 1K)

170.0 ~ 280.0 K ±(0.3%FS + (CJ error x 1)K + 1K)

270.0 ~ 350.0 K ±(0.3%FS + (CJ error x 1)K + 1K)

280.0 ~ 350.0 K ±(0.5%FS + (CJ error x 1)K + 1K)

NOTE: Unless otherwise specified, the measuring range listed below will be set as the factory default.

Input	Specification/Rating	Measuring Range
Universal input	K thermocouple	0.0 ~ 800.0°C
Voltage (V)	0 ~ 10V DC	0.0 ~ 100.0
Current (mA)	4 ~ 20mA DC	0.0 ~ 100.0

8. Explanation of Functions

All the details are mentioned here except the explanation of 5-5. Procedure of Setting in Screen Group 0.

8-1. Events

(1) Deviation alarm

An alarm action point is set by a deviation from target set value (SV).

For example, when the target set value is 20°C, +10°C should be set for higher limit deviation alarm in order to put an alarm in action at 30°C and higher.

To put an alarm in action at 30°C and lower when the target set value is 100°C, -70°C should be set for higher limit deviation alarm.

Higher limit deviation alarm must be higher than the target set value and lower limit deviation alarm must be lower than the target set value.

This is conveniently used to make the alarm action point follow deviation from the target set value. The setting range will be -1999~2000 unit.

(2) Absolute value alarm

An alarm action point is set by an absolute value.

For example, 50°C should be set for higher limit absolute alarm in order to put an alarm in action at 50°C and higher.

To put an alarm in action at 20°C and lower, 20°C should be set for lower limit absolute alarm.

Both higher limit and lower limit can be set at any value within the measuring range.

This alarm is convenient when the alarm action point is fixed.

(3) Standby action

In case the event standby action is set at 2 or 3 (on the screen 1-23 or 1-26), the alarm withholds its action even if the PV value is in the event action range (ON range) when the power is applied, when the setting value is changed, or when the standby is released.

The alarm will go on once the PV value leaves the event action range, the standby action is released, and the PV value enters the event action range again.

(4) No-standby action

In case the event standby action is set at 1 or 4 (on the screen 1-23 or 1-26), the alarm is output when the PV value enters the event action range, regardless of whether the power is applied, the SV changed, or the standby released.

(5) Control mode

In case the event standby action is set at 4 (on the screen 1-23 or 1-26), alarm is not output when scaleover has occurred or when the controller is in standby.

8-2. Selection of Event Standby Action Code

This is additional description for the explanation in 1-23 event 1 standby action code setting screen of the screen group 1.

The 1-26 event 2 standby action code setting screen is the same.

- ① Select a code from 1, 2 or 3 of the standby action code table when event output is used as an alarm.
- ② Select 4 when event output is used for control. Note, however, that setting 4 will not let event output ON even when the input error has occurred.
- ③ When 2 is set, the standby function is in action when power is applied or when standby is released.
- ④ When 3 is set, the standby function is in action when power is applied, when standby is released, or when SV in execution is changed.
- ⑤ A change to 1 or 4 while standby action is in execution, the standby action will be released immediately. When power is supplied and if a PV value is out of a range in which an event action is ON, standby action becomes invalid even when 2 or 3 has been set for standby action.

8-3. Alarm Action Diagrams

The followings are diagrams showing alarm actions that can be selected as event 1 and event 2.

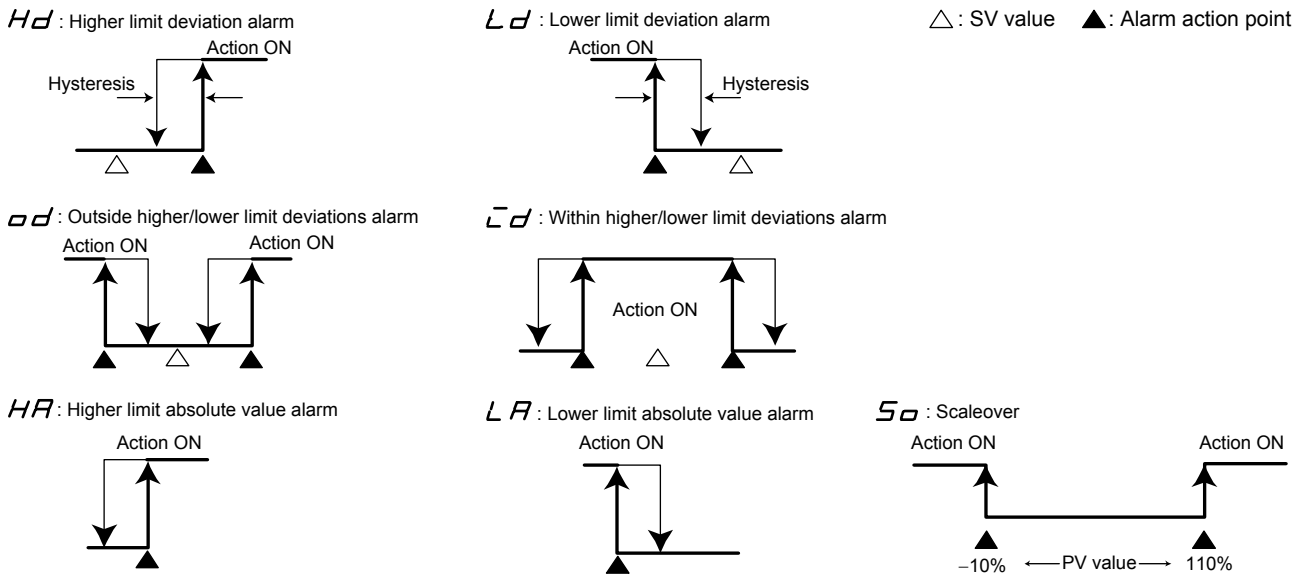

8-4. P.I.D.

(1) P (Proportional band)

A percentage at which control output varies with respect to a measuring range is set. Control output increases or decreases in proportion to a difference between PV and SV values. The narrower the proportional band, the more conspicuously output changes to strengthen proportional action. If it is too narrow, however, the result of control will be close to ON-OFF action.

(2) I (Integral time)

This is the function to correct an offset (constant deviation). The longer the integral time, the weaker the corrective action and the shorter the time the stronger the action but control result may be undulated due to integral hunting.

(3) D (Derivative time)

This is the function to estimate a change in control output, suppress overshoot caused by integration and improve control stability. The longer the derivative time, the stronger the derivative action but control result may be vibratile.

(4) MR (Manual Reset)

In PID action, an offset is corrected automatically by I, i.e., integration. When OFF is set for I, correction is not carried out and so output should be increased or decreased manually. This method is called manual reset.

8-5. Lower Limit and Higher Limit Setting Limiters

- ① Output limiter means to limit a minimum or maximum value of control output and this function is effective in specifying the lowest temperature or suppressing overshooting of control.
- ② Output limiter gives preference to a lower limit value. When a larger lower limit value than a higher limit value is set, the higher limit value is automatically changed to the lower limit value + 1%. In other words, it is not possible to set a higher limit value which is less than a lower limit + 1%.

8-6. Proportional Cycle Time

It should be within a range from 1~120 seconds in the case of contact output or SSR drive voltage output.

Proportional cycle time is ON time + OFF time.

The following diagram shows the correlation between proportional cycle time and control output.

① In case the output is 20 %.

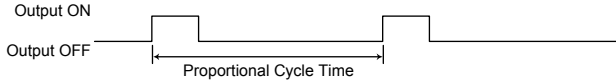

Output is ON during 20 % time of the proportional cycle time, and OFF during 80 % time of proportional cycle time.

② In case the output is 60 %.

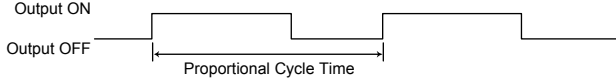

Output is ON during 60 % time of the proportional cycle time, and OFF during 40 % time of proportional cycle time.

8-7. Control Output Characteristics

(1) One-output

For heating action, set RA (reverse action). For cooling action, set DA (direct action).

(2) Two-output

① In case heating action is OUT1 and cooling action OUT2, set it at RA (reverse action).

② In case heating action is OUT1 and heating action OUT2, set it at DA (direct action).

Control output characteristics with two outputs are shown in the following diagrams. ① shows heating and cooling control and ② two-stage heating control.

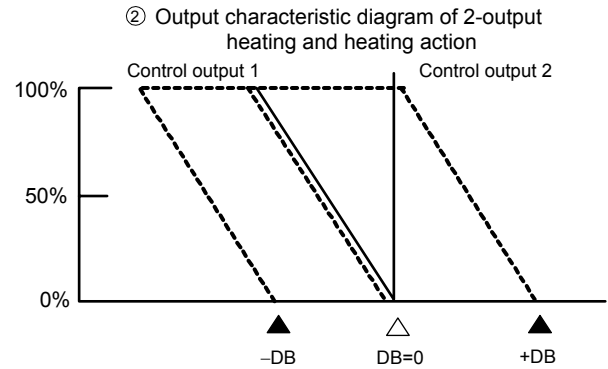
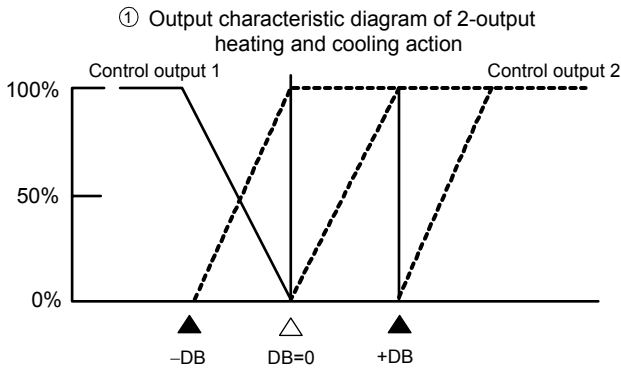

Control output 1: —
Control output 2: - - -
△: Target set value (SV)
▲: DB (dead band)

NOTE: In these diagrams, the manual reset (MR) value is -50%.

8-8. External input (DI)

The DI signal is detected by the level.

The ON-OFF detection is determined by a 150-msec continuum state across the SB,DI terminal.

The DI type can be specified on the 1-35 DI mode setting screen.

(1) Set value bias (SB)

This can be set by specifying SB (Set value Bias) to DI mode.

SB value can be set on the 0-7 set value bias setting screen.

When DI input signal is OFF : Execution SV = SV
When DI input signal is ON : Execution SV = SV + SB

Note that in case the execution SV lies outside the range of SV limiters, the actual executed SV is restricted by the SV limiter lower/higher limit values (which can be set on the 1-47 SV limiter lower limit value setting screen or 1-48 SV limiter higher limit value setting screen).

When auto tuning is executed, the SB signal level is maintained at the level just before the auto tuning was started, and SB signal detection is not performed.

(2) Standby (STBY)

This can be set by specifying STBY (standby) at DI mode.

If STBY is selected, the 0-3 STBY action setting screen is for monitoring only, and the setting cannot be performed.

When DI input signal is OFF: The controller is under control. PID control is executed.
When DI input signal is ON: The controller is on standby.

For STBY, refer to section 5-5 (4).

(3) Control action characteristics (ACT)

This can be set by specifying ACT (action characteristics) at DI mode.

If ACT is selected, the 1-45 control output characteristic setting screen is for monitoring only, and the setting cannot be performed.

When DI input signal is OFF: RA characteristics are assumed.
When DI input signal is ON: DA characteristics are assumed.

For RA/DA, refer to section 8-7.

8-9. Soft Start

It is the function to raise control output gradually in a set time upon applying power, releasing STBY, and at the time of return from scaleover to normal. The function effectively prevents excess current from being present in a heater or the like.

(1) Conditions of soft start function is put in action

- ① Under the automatic output mode, when power is applied, when STBY is released, or when a normal state is returned to from scaleover.
- ② When P (proportional band) is not OFF on the 1-2 output 1 proportional band setting screen.
- ③ When soft start time has been set, i.e., not OFF on the 1-46 soft start time setting screen.

(2) Conditions of soft start is released

- ① Soft start time has elapsed normally.
- ② An output value under soft start control exceeds a PID operated output value.
- ③ Soft start time is turned OFF by key operation.
- ④ The automatic output mode is changed to the manual output mode by key operation.
- ⑤ AT (auto tuning) is executed by key operation.
- ⑥ The setting of P (proportional band) is changed to OFF by key operation.
- ⑦ The measuring range of input is changed by key operation.
- ⑧ A control output characteristic is changed by key operation.
- ⑨ When the mode is switched to STBY.

9. Maintenance and Troubleshooting

9-1. Cause of Trouble and Troubleshooting

Problem	Cause	Remedy
1. Error code is displayed.	1. Refer to "9-2. Error Codes, Causes and Remedies."	1. Refer to "9-2. Error Codes, Causes and Remedies."
2. Displayed PV value seems to be incorrect.	1. Set measuring range code is different from that of input sensor/input signal. 2. Erroneous wiring to input terminals of sensor.	1. Check if set measuring range code is correct for input signal. 2. Correct wiring to input terminals of sensor.
3. Display on the front panel goes out and the instrument does not operate.	1. Problem with power supply and wiring connection. 2. Deterioration of the product.	1. Inspect portions related to power source and wire connection. Check wiring. 2. Examine the product and repair or replace.
4. Key unable to be operated.	1. Keylock is in effect. 2. Deterioration of the product. 3. In case communication function is added, the communication mode (Com) has been set.	1. Release keylock. 2. Examine and repair or replace the product. 3. Change the communication setting to the local mode (Loc).
5. ON-OFF action of control output is too fast.	1. Too small a value set for hysteresis of ON-OFF action.	1. Increase the hysteresis value of ON-OFF action.

9-2. Error Codes, Causes and Remedies

(1) Input measured value problems

Screen display	Problem	Cause	Remedy
<i>HHHH</i> (HHHH)	Higher limit side scaleover.	1. A break of thermocouple input wiring 2. A break of R.T.D. input A wiring 3. Input measured value exceeded higher limit of measuring range by 10%.	1. Check thermocouple input wiring for a possible break. If wiring has no problem, replace it. 2. Check R.T.D. input A wiring for a possible break. If wiring has no problem, replace R.T.D. 3. For voltage or current input, check the transmitting unit of measured values. Check if set code of measuring range is correct for input signal.
<i>LLLL</i> (LLLL)	Lower limit side scaleover.	Input measured value fell from lower limit of measuring range by 10%.	Check wiring of reverse polarity for measured value input or wiring for a possible break.
<i>b---</i> (b---)	A break of R.T.D. input wiring.	1. A break of B. 2. Breaks of ABB.	Check R.T.D. input terminals A, B and B for breaks. If wiring has no problem, replace R.T.D.
<i>CJHH</i> (CJHH)	Higher limit side scaleover of cold junction (CJ) of thermocouple input.	Ambient temperature of the product has exceeded 80°C.	1. Reduce ambient temperature to the level provided in the environment conditions for the product. 2. In case ambient temperature has not exceeded 80°C, examine the product.
<i>CJLL</i> (CJLL)	Higher limit side scaleover of cold junction (CJ) of thermocouple input.	Ambient temperature of the product has fallen to -20°C or lower.	1. Raise ambient temperature to the level provided in the environment conditions for the product. 2. In case ambient temperature has not fallen to -20°C or lower, examine the product.

(2) Heater break/loop alarm problems

Screen display	Problem	Cause	Remedy
<i>HbHH</i> (HBHH)	Input value from heater current detector has exceeded 55.0A.	Excess current.	1. Reduce the current. 2. Examine the product.
<i>HbLL</i> (HBLL)	The product is in trouble.	The product is in trouble.	Examine, repair or replace the product.

10. Record of Parameter Setting

For convenience sake, recording set values and selected items is recommended.
The initial values are of Code 05 (K)

Screen No.	Parameter (Item)/screen display	Initial value	Setting/Selection	Record
0-0	Basic screen	0 (0)	0	
0-1	Output 1 monitor			
0-2	Output 2 monitor			
0-3	STBY action	STBY.(<i>Stby</i>)	<i>E4E</i>	
0-4	AT action	At. (<i>At</i>)	<i>oFF</i>	
0-5	Event 1 set value setting	E1Hd. (<i>E1Hd</i>)	2000 units	
0-6	Event 2 set value setting	E2Hd. (<i>E2Hd</i>)	-1999 units	
0-7	Set value bias setting	Sb. (<i>Sb</i>)	0 unit	
1-0	Initial screen	PArA. (<i>PArA</i>)	<i>SEt</i>	
1-1	Keylock setting	KLc. (<i>PLc</i>)	<i>oFF</i>	
1-2	Output 1 proportional band setting	P. (<i>P</i>)	<i>30</i>	
1-3	Output 1 hysteresis	dF. (<i>dF</i>)	20 units	
1-4	Output 1 integral time	I. (<i>I</i>)	<i>120</i>	
1-5	Output 1 derivative time	d. (<i>d</i>)	<i>30</i>	
1-6	Output 1 manual reset	mr. (<i>nr</i>)	<i>00</i>	
1-7	Output 1 target value function	SF. (<i>SF</i>)	<i>0.40</i>	
1-8	Output 1 lower limit output limiter	o-L. (<i>o-L</i>)	<i>00</i>	
1-9	Output 1 higher limit output limiter	o-H. (<i>o-H</i>)	<i>1000</i>	
1-10	Output 1 proportional cycle time	o-C. (<i>o-C</i>)	Y: 30, P: 3	
1-11	Output 2 proportional band setting	P2. (<i>P2</i>)	<i>30</i>	
1-12	Output 2 hysteresis	dF2. (<i>dF2</i>)	20 units	
1-13	Output 2 integral time	I2. (<i>I2</i>)	<i>120</i>	
1-14	Output 2 derivative time	d2. (<i>d2</i>)	<i>30</i>	
1-15	Output dead band	db2. (<i>db2</i>)	0 unit	
1-16	Output 2 target value function	SF2. (<i>SF2</i>)	<i>0.40</i>	
1-17	Output 2 lower limit output limiter	o-L2. (<i>o-L2</i>)	<i>00</i>	
1-18	Output 2 higher limit output limiter	o-H2. (<i>o-H2</i>)	<i>1000</i>	
1-19	Output 2 proportional cycle time	o-C2. (<i>o-C2</i>)	Y: 30, P: 3	
1-20	Event at STBY	StEV. (<i>StEV</i>)	<i>oFF</i>	
1-21	Event 1 type	E1-m. (<i>E1-n</i>)	<i>Hd</i>	
1-22	Event 1 hysteresis	E1-d. (<i>E1-d</i>)	5 units	
1-23	Event 1 standby action	E1-i. (<i>E1-c</i>)	<i>1</i>	
1-24	Event 2 type	E2-m. (<i>E2-n</i>)	<i>Ld</i>	
1-25	Event 2 hysteresis	E2-d. (<i>E2-d</i>)	5 units	
1-26	Event 2 standby action	E2-i. (<i>E2-c</i>)	<i>1</i>	
1-27	Heater current monitor	Hb-A. (<i>Hb-A</i>)		
1-28	Heater break/loop alarm	Hb-m. (<i>Hb-n</i>)	<i>Lc</i>	
1-29	Heater break/loop alarm standby	Hb-i. (<i>Hb-c</i>)	<i>oFF</i>	
1-30	Heater break alarm value	Hb-S. (<i>Hb-S</i>)	<i>oFF</i>	
1-31	Heater loop alarm value	HL-S. (<i>HL-S</i>)	<i>oFF</i>	
1-32	Analog output type	Ao-m. (<i>Ao-n</i>)	<i>PH</i>	
1-33	Analog output scaling lower limit	Ao-L. (<i>Ao-L</i>)	<i>00</i>	
1-34	Analog output scaling higher limit	Ao-H. (<i>Ao-H</i>)	<i>8000</i>	
1-35	DI mode	Di. (<i>dc</i>)	<i>5b</i>	
1-36	Communication mode setting	comm.(<i>com-n</i>)	<i>Loc</i>	
1-37	Communication protocol	Prot. (<i>Prot</i>)	<i>Sh-cn</i>	
1-38	Communication address	Addr. (<i>Addr</i>)	<i>1</i>	
1-39	Communication data format	dAtA. (<i>dAtA</i>)	<i>7E 1</i>	
1-40	Start character	SchA. (<i>SchA</i>)	<i>St4</i>	
1-41	BCC operation type	bcc. (<i>bcc</i>)	<i>1</i>	
1-42	Communication speed	bPS. (<i>bPS</i>)	<i>1200</i>	
1-43	Communication delay time	dely. (<i>dELy</i>)	<i>20</i>	
1-44	Communication memory mode	mem. (<i>ne-n</i>)	<i>EEP</i>	
1-45	Control output characteristic	Act. (<i>Act</i>)	<i>rA</i>	
1-46	Soft start time	Soft. (<i>Soft</i>)	<i>oFF</i>	
1-47	SV limiter lower limit value	SV-L. (<i>SV-L</i>)	<i>00</i>	
1-48	SV limiter higher limit value	SV-H. (<i>SV-H</i>)	<i>8000</i>	
1-49	PV bias value	PV-b. (<i>PH-b</i>)	0 unit	
1-50	PV filter time	PV-F. (<i>PH-F</i>)	<i>0</i>	
1-51	Measuring range codes	Universal: V: A:	<i>rAnG</i> (<i>rAnG</i>) <i>86</i> <i>rAnG</i> (<i>rAnG</i>) <i>92</i>	
1-52	Temperature unit	Unit. (<i>Un-c</i>)	<i>c</i>	
1-53	Input scaling lower limit	Sc-L. (<i>Sc-L</i>)	<i>00</i>	
1-54	Input scaling higher limit	Sc-H. (<i>Sc-H</i>)	<i>8000</i>	
1-55	Input scaling decimal point position	Scdp. (<i>ScdP</i>)	<i>00</i>	
1-56	CJ external/internal switching	Cj. (<i>CJ</i>)	<i>cn-c</i>	
1-57	PV display at standby setting	Disp. (<i>dc-SP</i>)	<i>PH</i>	

11. Specifications

Display

- Digital display: Measured value (PV)/7 segments red LED 4 digits
Target set value (SV)/7 segments green LED 4 digits
- Display accuracy: $\pm(0.3\%FS + 1 \text{ digit})$
Excluding reference contact temperature compensation accuracy of thermocouple input.
Refer to "Table of Measuring Range Codes" for individual details.
- Display accuracy maintaining range: $23^{\circ}C \pm 5^{\circ}C (18\sim 28^{\circ}C)$
- Display resolution: Differs by measuring range (0.001, 0.01, 0.1 and 1)
- Measured value display range: $-10\%\sim 110\%$ of measuring range
- Display updating cycle: 0.25 seconds
- Action display/color: 7 type, LED lamp display
Control output (OUT1, OUT2)/Green
Event (EV1, EV2)/Orange
Auto tuning (AT)/Green
Manual control output (MAN)/Green
Set value bias, communication (SB/COM)/Green

Setting

- Setting method: By operating 4 keys (\odot , \blacktriangle , \blacktriangledown and ENT) on the front panel
- Target value setting range: Same as measuring range (within setting limiter)
- Setting limiter: Individual setting for higher and lower limits, any value is selectable within measuring range (Lower limit value < Higher limit value)

Input

- Type of input: Selectable from Universal (TC, Pt, mV), voltage (V) and current (mA)
- Thermocouple: B, R, S, K, E, J, T, N, PL II, WR5-26 (UL (DIN 43710)), AuFe-Cr (Kelvin scale)
Input impedance: 500k Ω minimum
External resistance tolerance: below 100 Ω
Burnout function: Standard feature (up scale)
Reference contact compensation accuracy: $\pm 1^{\circ}C$ (within the accuracy maintaining range ($23 \pm 5^{\circ}C$))
 $\pm 2^{\circ}C$ (between 5 and $45^{\circ}C$ of ambient temperature)
- R.T.D.: Pt100/JPt100, 3-wire type
Normal current: 0.25 mA
Lead wire tolerance: 5 Ω maximum/wire (3 lead wires should have the same resistance.)
- Voltage mV: $-10\sim 10, 0\sim 10, 0\sim 20, 0\sim 50, 10\sim 50, 0\sim 100\text{mv DC}$
V: $-1\sim 1, 0\sim 1, 0\sim 2, 0\sim 5, 1\sim 5, 0\sim 10\text{V}$
- Input impedance: 500k Ω minimum
- Current mA: $0\sim 20, 4\sim 20\text{mA DC}$
- Receiving impedance: 250 Ω
- Input scaling function: Scaling possible for voltage (mV, V) or current (mA) input
Scaling range: $-1999\sim 9999$ counts
Span: 10~5000 counts
Position of decimal point: None, 1, 2 and 3 decimal places
- Sampling cycle: 0.25 seconds
- PV bias: $-1999\sim 2000$ units
- PV filter: 0~100 seconds
- Cold junction compensation: Selectable between internal and external by front key
- Isolation: Control input not insulated from system, set value bias, and CT input but insulated from others

Control

- Control mode
With 1-output: Expert PID control with auto tuning function
RA (reverse characteristic): Heating action
DA (direct characteristic): Cooling action
With 2-output: Expert PID control with auto tuning function + PID control
RA (reverse characteristic): Heating action (OUT1) and cooling action (OUT2)
DA (direct characteristic): 2-stage heating action

- Output action mode: MAN (manual), AUTO (automation) / STBY (standby)
- Event at STBY: ON/OFF
- Type of control/rating: Contact/1 a 240V AC 2A (resistive load) 1.2A (inductive load)
(Common to Output 1 and 2): SSR drive voltage/12V $\pm 1.5\text{V DC}$ (Maximum load current 30mA)
Current/4~20mA DC (Maximum load resistance 600 Ω)
Voltage/0~10V DC (Maximum load current 2mA)
- Control output resolution: Control output 1: approx. 0.0125% (1/8000)
Control output 2: approx. 0.5% (1/200)
- Control output 1
Proportional band (P): OFF, 0.1~999.9% (ON-OFF action by OFF)
Integral time (I): OFF, 1~6000 seconds (P or PD action by OFF)
Derivative time (D): OFF, 1~3600 seconds (P or PI action by OFF)
Target value function: OFF, 0.01~1.00
ON-OFF hysteresis: 1~999 units (Effective when P=OFF)
Manual reset: $-50.0\sim 50.0\%$ (Effective when I=OFF)
Higher/lower limit output limiter: Lower limit 0.0~99.9%, higher limit 0.1~100.0% (Lower limit value < Higher limit value)
Proportional cycle: 1~120 seconds (for contact and SSR drive voltage output)
- Control output 2 (option)
Proportional band (P): OFF, 0.1~999.9% (ON-OFF action by OFF)
Integral time (I): OFF, 1~6000 seconds (P or PD action by OFF)
Derivative time (D): OFF, 1~3600 seconds (P or PI action by OFF)
Target value function: OFF, 0.01~1.00
ON-OFF hysteresis: 1~999 units (Effective when P=OFF)
Dead band: $-1999\sim 5000$ units (Overlap with a negative value)
Higher/lower limit output limiter: Lower limit 0.0~99.9%, higher limit 0.1~100.0% (Lower limit value < Higher limit value)
Proportional cycle: 1~120 seconds (for contact and SSR drive voltage output)
- Manual control
Output setting range: 0.0~100.0%
Setting resolution: 0.1%
Manual \leftrightarrow auto switching: Balanceless bumpless transfer (within proportional range, however.)
- Soft start: OFF, 1~100 seconds
- AT point: SV value in execution
- Control output characteristic: RA (reverse characteristic)/DA (direct characteristic) switching by front key
Contact output isolated from all.
Analog output not insulated from SSR drive voltage, current and voltage but insulated from others. (In case another output is also of SSR drive voltage, current or voltage, however, two outputs are not insulated from each other.)
- Isolation: Analog output not insulated from SSR drive voltage, current and voltage but insulated from others. (In case another output is also of SSR drive voltage, current or voltage, however, two outputs are not insulated from each other.)

Event output (option)

- Number of event points: 2 points of EV1 and EV2
- Types: Selectable from the following 9 types for EV1 and EV2:
OFF: No selection
Hd: Higher limit deviation
Ld: Lower limit deviation
od: Outside higher/lower limit deviations
cd: Within higher/lower limit deviations
HA: Higher limit absolute value
LA: Lower limit absolute value
So: Scaleover
Hb: Heater break/loop alarm
- Event setting range: Absolute values (both higher limit and lower limit): Within measuring range
Deviations (both higher limit and lower limit): $-1999\sim 2000$ units
Higher/lower limit deviations (within/outside): 0~2000 units
- Event action: ON-OFF action
- Hysteresis: 1~999 units

- Standby action: Selectable from the following 4 types;
EV1 and EV2:
 - 1 Without standby action.
 - 2 Standby when power is applied or when standby is released.
 - 3 Standby when power is applied, when standby is released or when SV value in execution is changed.
 - 4 Control mode without standby action (No alarm is output at the time of abnormal input).
- Output type/rating: Contact (1a × 2 points common)/240V AC 1A (resistive load)
- Output updating cycle: 0.25 seconds

■ Heater break/heater loop alarm (option)

- Heater break/loop detection only for OUT1 (Selectable when output type is contact or SSR drive voltage)
- Current capacity: 30A or 50A CT to be designated when ordering.
- Alarm action: Heater current is detected by external CT provided as an accessory.
When heater break is detected while control output is ON=Alarm output ON
When heater loop alarm is detected while control output is OFF=Alarm output ON
- Current setting range: OFF, 0.1~50.0A (Alarm action is stopped by setting OFF)
- Setting resolution: 0.1A
- Current display range: 0.0~55.0A
- Display accuracy: ±2.0A (Sine wave at 50Hz)
- Minimum time to identify action: 0.25 seconds common to ON and OFF (every 0.5 seconds)
- Alarm retention mode: Selectable from lock (to retain) and real (not to retain).
- Standby action: Selectable from without (OFF) and with (ON).
- Sampling cycle: 0.5 seconds
- Isolation: CT input not insulated from system and other inputs but insulated from the rest.

■ DI (option)

- Number of input points: 1 point
- Setting range: ~1999~5000 units
- Action input: No-voltage contact or open collector (level action) about 5V DC, 1mA maximum
- Minimum level retention time: 0.15 seconds
- DI types:
 - 1) None
 - 2) SB; set value bias
 - 3) STBY; standby
 - 4) ACT; control action characteristics
- Isolation: Action input not insulated from system and other inputs but insulated from others

■ Communication function (option)

- Type of communication: RS-232C, RS-485
- Communication system: RS-232C : 3-line type half duplex system
RS-485 : 2-line type half duplex system (RS-485 is of half-duplex multi-drop (bus) system)
- Communication distance: RS-232C : The longest: 15 m
RS-485 : The longest: 500 m (depending on conditions)
- Number of connectable instruments: RS-232: 1, RS-485: up to 31
- Synchronization system: Start-stop synchronization system
- Communication speed: 1200, 2400, 4800, 9600, 19200 bps
- Communication address: 1~255
- Communication delay time: 1~100 (× 0.512 msec)
- Communication memory mode: EEP/RAM/r_E
- Communication protocol (1): Shimaden protocol
Data format: 7E1, 7E2, 7N1, 7N2, 8E1, 8E2, 8N1, 8N2
Control code: STX, ETX, CR, STX, ETX, CRLF, @, _ :_ CR
Communication BCC: Add, Add two's cmp, XOR, None
Communication code: ASCII code
- Communication protocol (2): MODBUS ASCII mode
Data format: 7E1, 7E2, 7N1, 7N2
Control code: CRLF
Error check: LRC check
Function code: 03H, 06H (Hex)
1) 03H, read data
2) 06H, write data
- Communication protocol (3): MODBUS RTU mode
Data format: 8E1, 8E2, 8N1, 8N2
Control code: None
Error check: CRC-16
Function code: 03H, 06H (Hex)
1) 03H, read data
2) 06H, write data
- Isolation: Communication signals insulated from system, each input and each output.

■ Analog output (option)

- Number of output points: 1 point
- Type of analog output: Selectable from measured value, target value (SV in execution), control output 1 and control output 2.
- Output signal/rating: 4~20mA DC/Maximum load resistance 300 Ω
0~10V DC/Maximum load current 2mA
0~10mV DC/Output impedance 10 Ω
- Output scaling: Measured value, target value: Within measuring range (reverse scaling possible)
Control output 1 and 2 0.0~100.0% (reverse scaling possible)
- Output accuracy: ±0.3% FS (with respect to displayed value)
- Output resolution: About 0.01% (1/10000)
- Output updating cycle: 0.25 seconds
- Isolation: Analog output insulated from system and inputs but not insulated from control output except contact output.

■ General specifications

- Data storage: Non-volatile memory (EEPROM)
- Environmental conditions for instrument operation:
 - Temperature: -10~50°C
 - Humidity: 90% RH or less (no dew condensation)
 - Height: 2000m from the sea level or lower
 - Category: II
 - Degree of pollution: 2
- Storage temperature: -20~65°C
- Supply voltage: Either 100~240V AC±10% 50/60Hz or 24V AC/DC±10% to be designated.
- Power consumption: SR91: 100~240V AC 11VA maximum for AC; 6W for DC 24V; 7VA for AC 24V
SR92, SR93 and SR94: 15VA maximum for 100~240V AC; 8W for DC 24V; 9VA for AC 24V
- Input/noise removal ratio: 50 dB or higher in normal mode (50/60 Hz)
130 dB or higher in common mode (50/60 Hz)
- Conformity with standards: Safety: IEC61010 and EN61010-1
EMC: EN61326
- Insulation resistance: Between input/output terminals and power terminal 500V DC 20MΩ or above;
Between input/output terminals and protective conductor terminal 500V DC 20MΩ or above
- Dielectric strength: Between input/output terminals and power terminal 2300V AC/minute; Between power terminal and protective conductor terminal 1500V AC/minute
- Protective structure: Only front panel has dust-proof and drip-proof structure equivalent to IP66.
- Material of case: PPO resin molding (equivalent to UL94V-1)
- External dimensions: SR91: H48 × W48 × D111 (Panel depth: 100) mm
SR92: H72 × W72 × D111 (Panel depth: 100) mm
SR93: H96 × W96 × D111 (Panel depth: 100) mm
SR94: H96 × W48 × D111 (Panel depth: 100) mm
- Mounting: Push-in panel (one-touch mount)
- Panel thickness: 1.0~4.0 mm
- Panel cutout: SR91: H45 × W45 mm
SR92: H68 × W68 mm
SR93: H92 × W92 mm
SR94: H92 × W45 mm
- Weight: SR91: Approximately 170 g
SR92: Approximately 280 g
SR93: Approximately 330 g
SR94: Approximately 240 g



**上海斯通电子科技有限公司
上海岛电自动化控制系统工程有限公司**

地址：上海市奉贤区张翁庙路525号晨日科技园F栋302室

电话：(021)66670770 66670778

传真：66670776

手机：13701698568

E-mail: qjhycy@163.com

<http://www.sitong.net.cn>

<http://www.shimaden.net.cn>

SHIMADEN CO., LTD.



请关注斯通公众号